

# MOULDINGS UNLIMITED, INC.

## CONTACT INFORMATION

Mail: Mouldings Unlimited, Inc.  
P. O. Box 595  
Cartersville, GA 30120

Shipping: Mouldings Unlimited, Inc.  
3439 HWY 411 N.E.  
White, GA 30184

Phone: 770-383-8100

Fax: 770-383-8070

Web: [www.mouldingsunlimited.com](http://www.mouldingsunlimited.com)  
[www.mouldingsunlimited.net](http://www.mouldingsunlimited.net)

Mail: Trim Depot  
P. O. Box 595  
Cartersville, GA 30120

Shipping: Trim Depot  
3939 Royal Drive, Suite 111  
Kennesaw, GA 30144

Phone: 770-794-TRIM (8746)

## ACCURACY OF THIS CATALOG

We have tried to ensure that the information contained in this catalog is accurate. We cannot be responsible for misprints or errors. This catalog is merely a guide and is meant to aid the customer in the selection of our products. The drawings contained herein represent the profiles closely but they are not CAD drawings. There may be slight differences between the actual profile and these drawings. The differences, however, will be slight and should not have any affect. Where the exact size of a profile is critical, for whatever reason, it is the customer's responsibility to alert us to this fact so that we can confirm the information and provide an actual sample and/or CAD drawing. Duplication of this catalog, in whole or part, without the written permission of Mouldings Unlimited, Inc. is strictly prohibited.

## STOCK PROGRAM

Currently, we have one of largest selection of mouldings available, and we are always changing our profiles to meet market demands. We stock over 150 different profiles in six different species of wood, which includes cherry, mahogany, maple, oak, pine, and poplar. We offer a finger jointed product in over 200 profiles, which is currently our biggest seller. When considering our finger jointed products, we highly recommend our primed application. We achieve excellence in our primed product by applying two coats of water based primer and additionally buffing the product to create a smooth finished surface. We strongly recommend each customer to check inventory on catalog profiles. If the profile is not in inventory we will do our utmost to produce the item in a timely manner.

## CUSTOM MOULDINGS

When a customer requires a profile that is different from those shown in this catalog we can certainly accommodate them. We make all of our tooling so we can match your profile. We require a drawing or sample in order to make the tooling. There is a nominal tooling charge and setup fee for this service. The amount of these charges will depend on the size of the profile, the detail of the profile, and the quantity required.

## DELIVERY

Delivery charge for a particular order will be determined at the time the order is placed. Factors that impact the delivery charge include the location, the size of the order, and the delivery schedule. However, we will do whatever we can to deliver the moulding at an affordable price.

## PRICING

We have a very good track record for having competitive pricing and for delaying price increases. However, due to fluctuating raw material cost product pricing is not always constant. Custom woods are more vulnerable to cost increases than stock mouldings. For these reasons, we reserve the right to increase our prices without notice.

## RETURN POLICY

We require 25% restocking fee. This will be given under certain stipulations. All wood must be brought back the way it was picked up. We do not except wood that has been cut or damaged. We do not allow custom jobs to be returned.

MU#		PAGE
2	Apron	4
3	Casing	11
4	Dentil Crown	2
5	Cap Mould	24
7	Dentil Crown	2
9	Dentil Crown	2
14	Cove Mould	25
15	Cove Mould	25
17	Crown	1
18	Dentil Mould	2
20	Mantle Mould	13
22	Apron	4
23	Bar Mould	30
25	Bar Mould	30
27	Plint	11
28	Rake Mould	10
29	Rake Mould	10
34	O G Stop	25
39	Window Stool	19
41	Panel Mould	27
42	Panel Mould	27
43	Panel Mould	27
44	Panel Mould	14
47	Crown	1
49	Crown	1
50	Crown	8
52	Crown	1
57	Crown	1
60	Crown	1
61	Crown	1
65-B	Base	40
68-E	Base	40
70	Bed Mould	10
74	Bed Mould	10
97	Cove Mould	25
100	Cove Mould	25
103	Quarter Round	25
105	Quarter Round	25
107	Quarter Round	25
108	Quarter Round	25
111	Quarter Round	25
122	Half Round	24
124	Half Round	24
127	Shoe Mould	32
129	Shoe Mould	32
142	Screen Mould	24
144	Screen Mould	24
152	Glass Bead	25
162	Base Cap	26
163	Base Cap	26
164	Base Cap	26
165	Base Cap	26

MU#		PAGE
167	Base Cap	26
169	Base Cap	26
172	Base Cap	26
175	Base Cap	26
177	Base Cap	26
180	Brick Mould	10
187	Brick Mould	10
195	Mantle Mould	13
197	Plinth	13
205	Quarter Round	24
206	Quarter Round	24
222	Half Round	24
239	Window Stool	19
272	Base Cap	26
273	Picture Mould	24
280	Back Band	14
281	Back Band	14
295	Picture Mould	24
325C	Crown	41
356	Casing	14
366	Casing	14
371	Casing	14
425C	Crown	41
443	Cove Crown	5
445	Casing	14
447	Cove Crown	5
448	Cove Crown	5
449	Cove Crown	5
525C	Crown	41
618	Base	21
620	Base	21
623	Base	21
707	Dentil Mould	2
709	Dentil Mould	2
789	Cap Mould	26
804	Chair Rail	23
816	Stop	25
820	Stop	25
842	Screen Mould	24
894	Base Cap	27
896	Base Cap	27
900	Rope Mould	3
902	Rope Mould	3
904	Rope Mould	3
906	Rope Mould	3
910	Rosette	37
912	Rosette	37
914	Rosette	37
916	Rosette	37
918	Rosette	37
935	Colonial Stop	25
936	Colonial Stop	25

MU#		PAGE
938	Colonial Stop	25
940	Colonial Stop	25
941	Colonial Stop	25
967	Cap Mould	26
1001	Chair Rail	22
1102	Rail	26
1155	Cove Crown	6
1175	Cove Crown	6
1187	Window Stool	19
1195	Cove Crown	6
1197	Cove Crown	6
1199	Cove Crown	6
1235	Crown	8
1243	Crown	9
1245	Crown	9
1249	Crown	8
1250	Crown	8
1254	Crown	9
1255	Crown	8
1260	Crown	9
1271	Panel Mould	27
1273	Panel Mould	27
1275	Panel Mould	27
1277	Panel Mould	27
1279	Panel Mould	27
1281	Panel Mould	27
1301	Base Cap	26
1303	Chair Rail	22
1305	Chair Rail	22
1325	Cove Crown	6
1362	Window Stool	19
1364	Window Stool	19
1468	Crown	4
1478	Crown	4
1567	Chair Rail	22
1577	Chair Rail	22
1625	Cove Crown	6
1643	Rail	26
1905	Chair Rail	22
1910	Chair Rail	22
1912	Chair Rail	22
2024	S4S	29
2032	S4S	29
2040	S4S	29
2048	S4S	29
2056	S4S	29
2072	S4S	29
2088	S4S	29
2107	T & G	28
2120	S4S	29
2141	S4S	33
2142	S4S	33



# MOULDINGS UNLIMITED, INC.



MU 52  
CROWN  
5/8 x 2-3/4

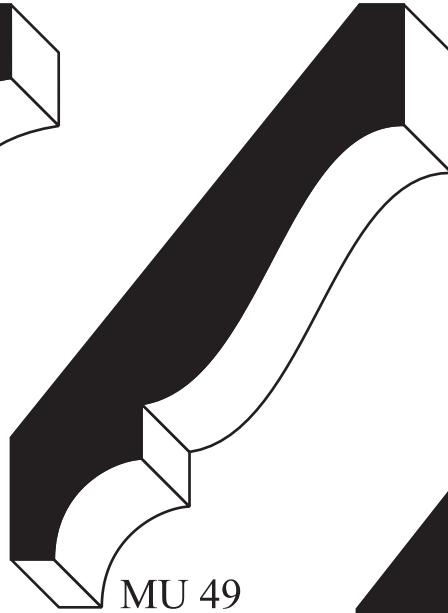

MU 49  
CROWN  
5/8 x 3-9/16



MU 47  
CROWN  
11/16 x 4-9/16



MU 60  
CROWN  
9/16 x 1-3/4



MU 61  
9/16 X 1-5/8

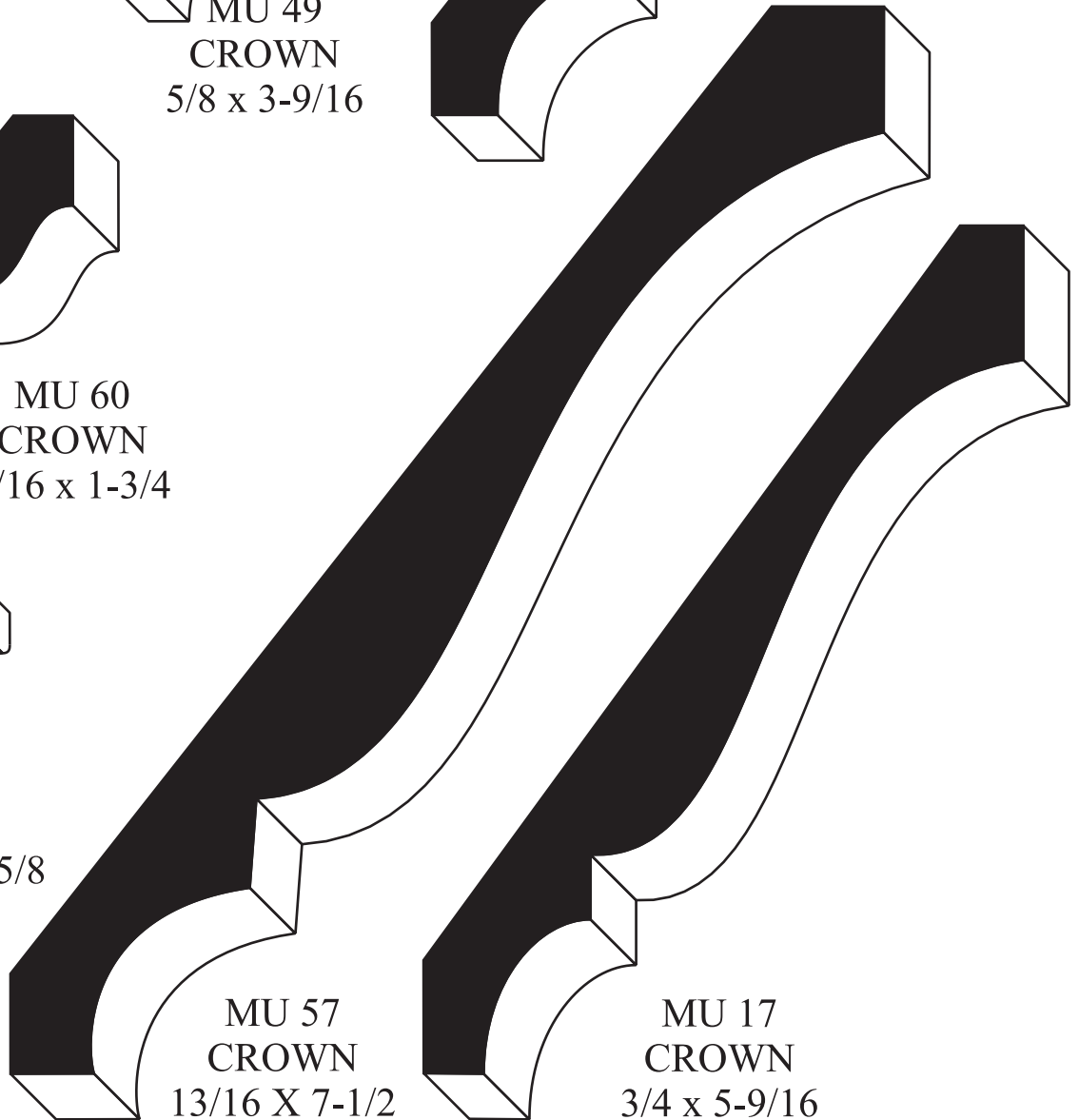

MU 57  
CROWN  
13/16 X 7-1/2



MU 17  
CROWN  
3/4 x 5-9/16

# MOULDINGS UNLIMITED, INC.

## DENTIL CROWNS

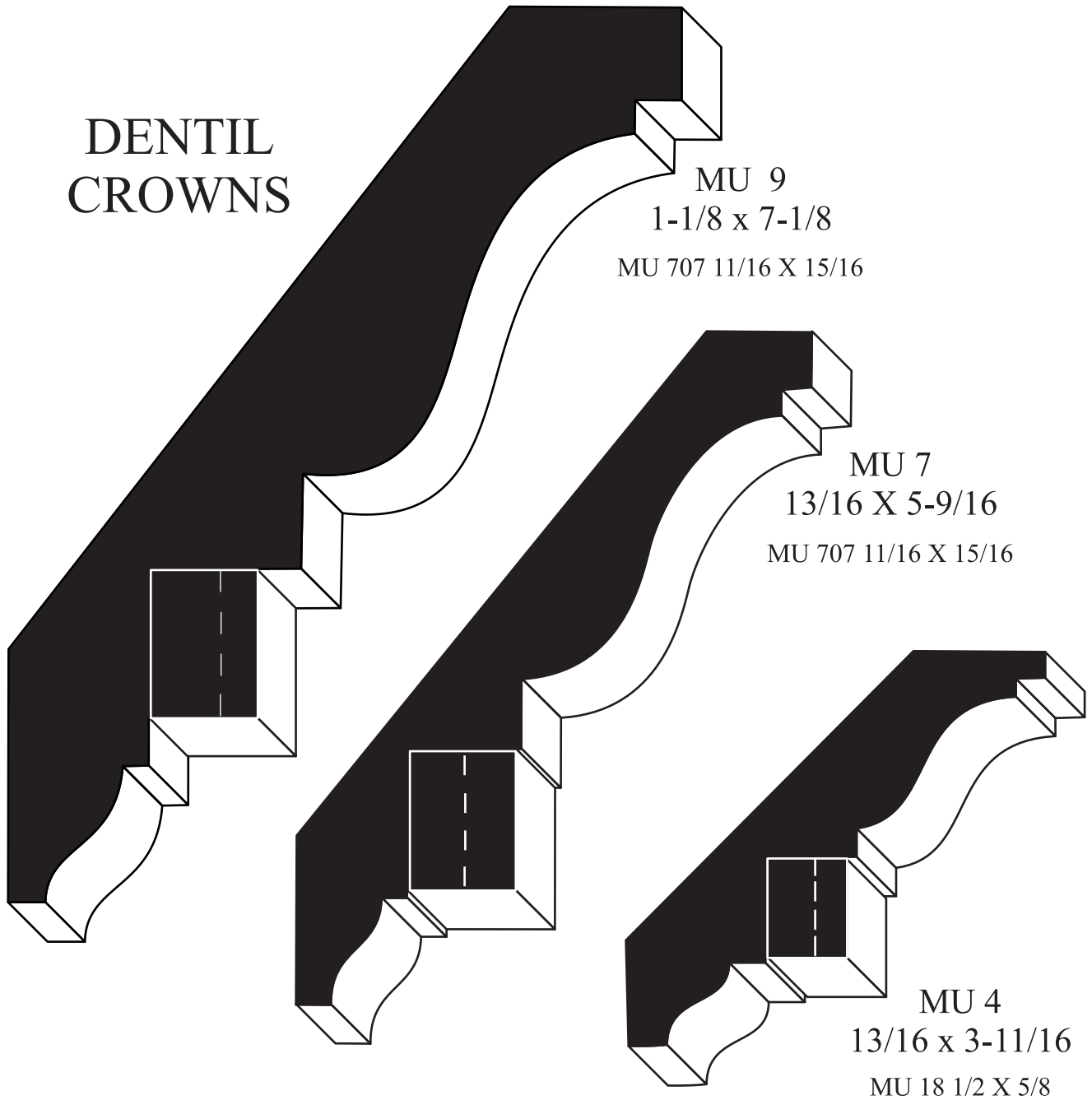

## DENTIL MOULD



MU 18 1/2 X 5/8

MU 707 11/16 X 15/16

MU 709 7/8 X 1-1/16

# MOULDINGS UNLIMITED, INC.



MU 900 3/8 in Rope Moulding

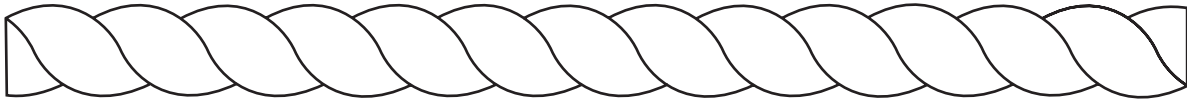

MU 902 1/2 in Rope Moulding

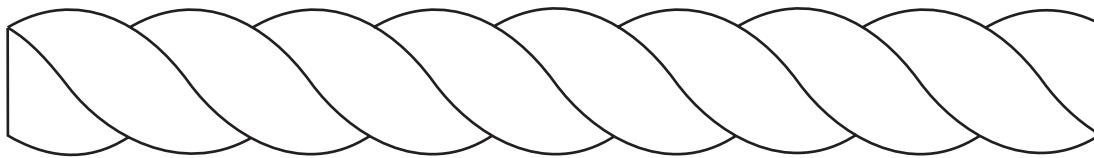

MU 904 3/4 in Rope Moulding

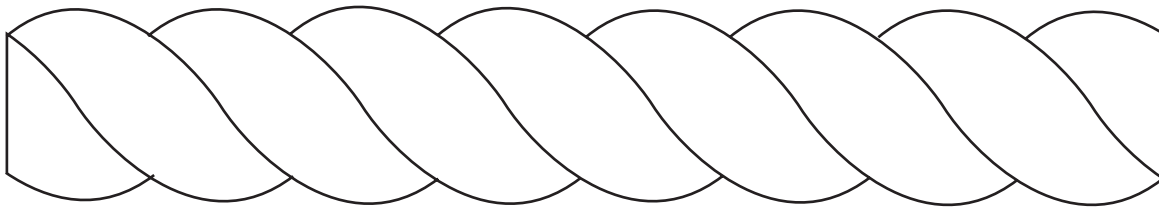

MU 906 1 in Rope Moulding

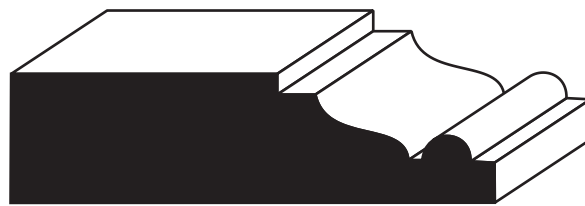

MU 2 3/4 X 2-1/2



MU 22 3/4 X 3-1/2

# MOULDINGS UNLIMITED, INC.

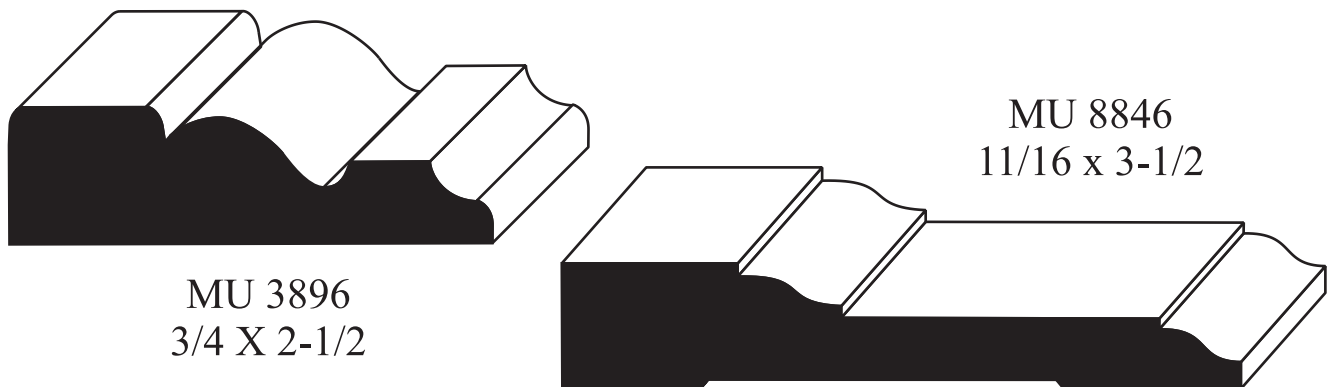
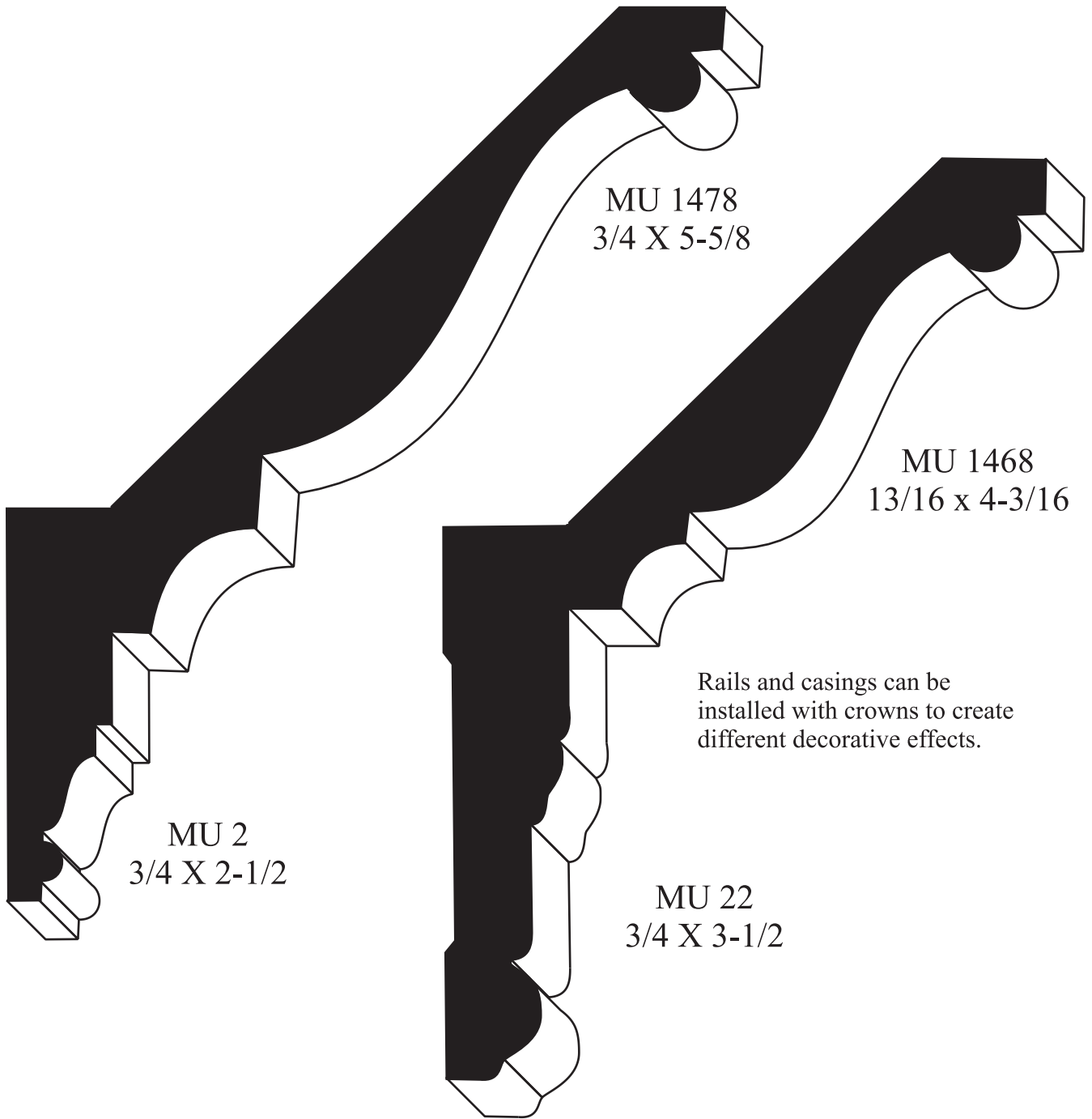

# MOULDINGS UNLIMITED, INC.

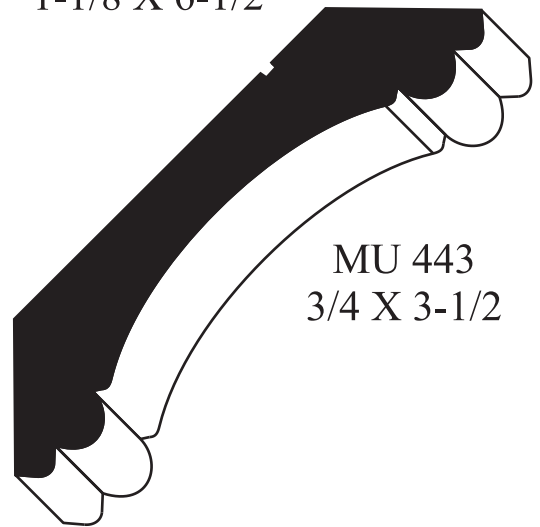
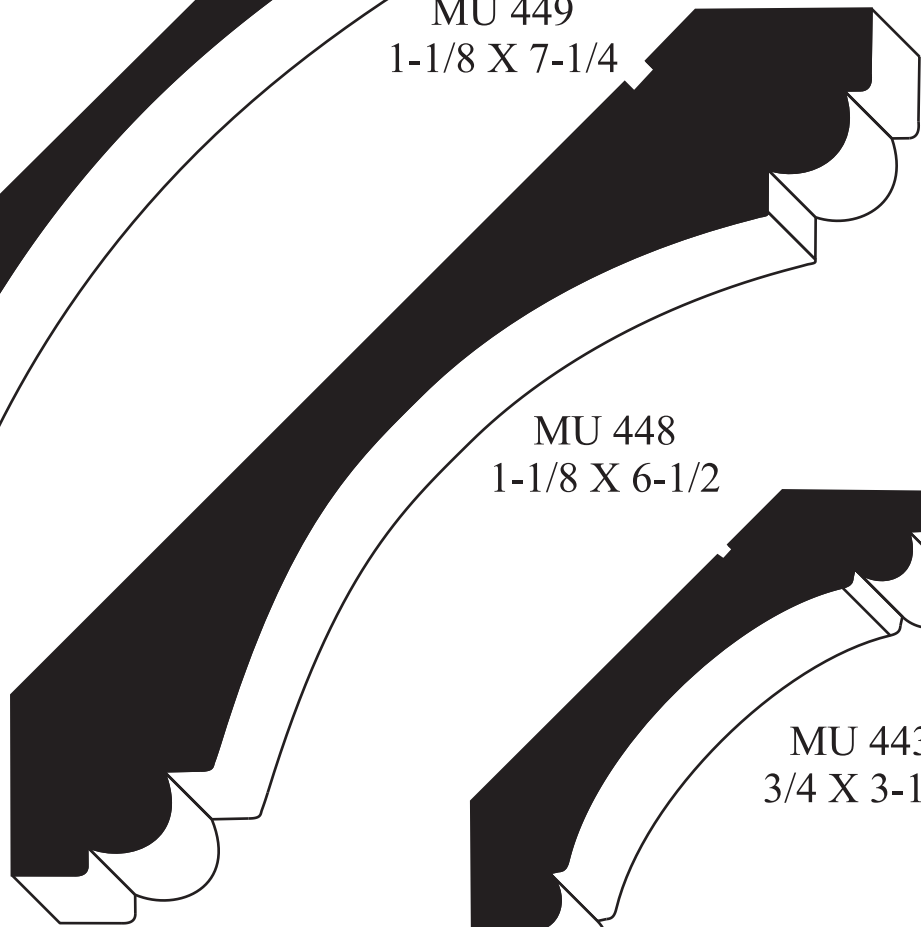
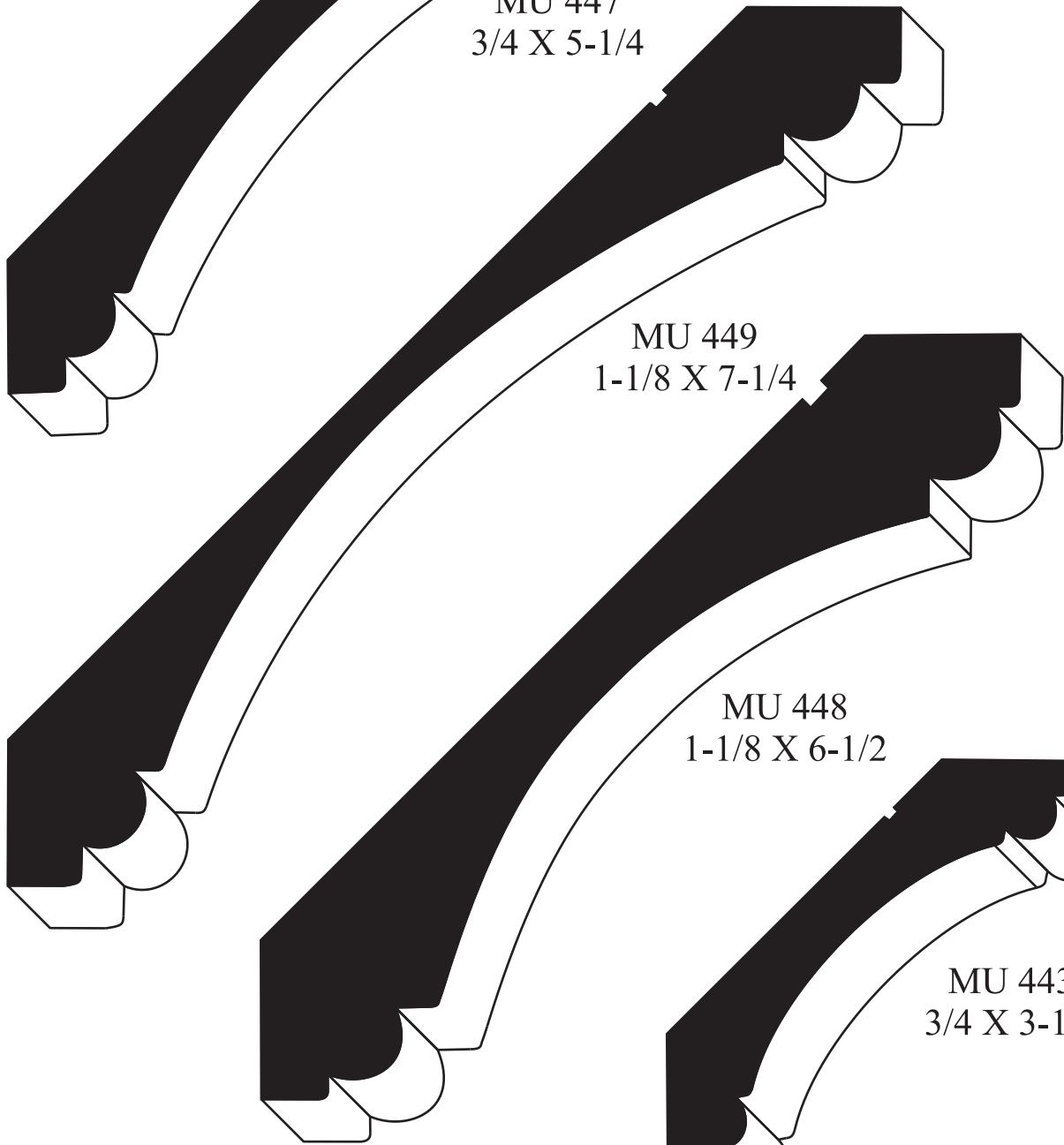
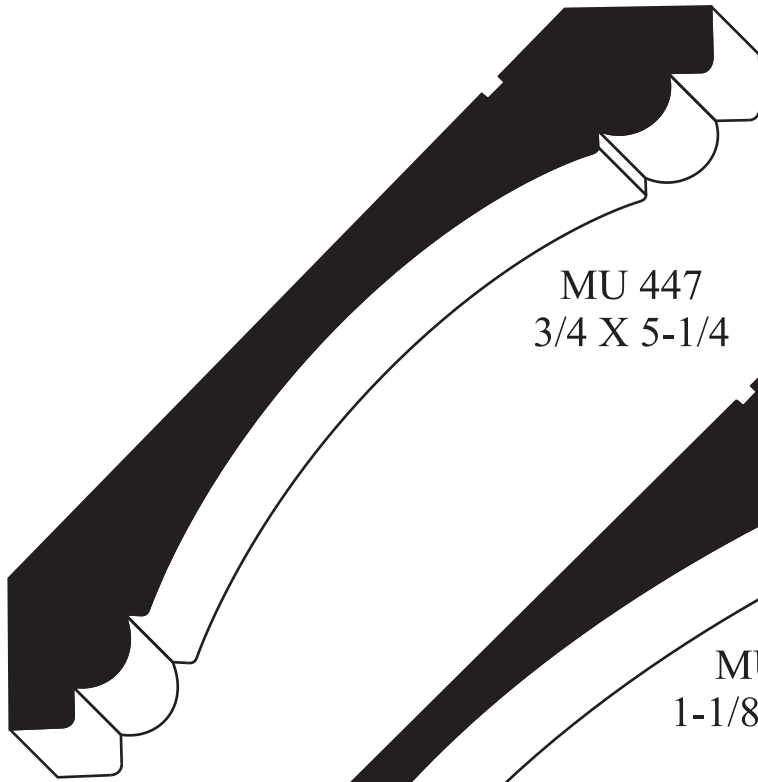



# MOULDINGS UNLIMITED, INC.

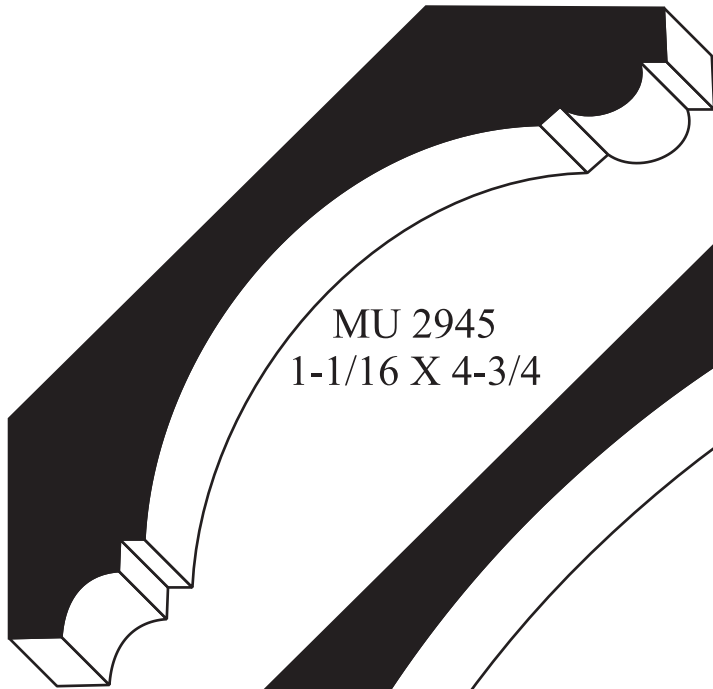

MU 2945  
1-1/16 X 4-3/4



MU 1325  
11/16 X 3-5/16



MU 1199  
1-1/8 X 7-1/4

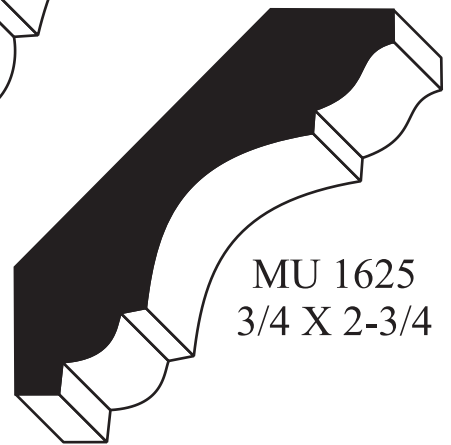

MU 1625  
3/4 X 2-3/4



MU 1197  
1-1/16 X 5-1/2

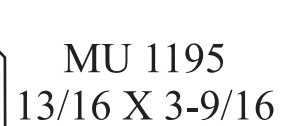

MU 1195  
13/16 X 3-9/16



MU 1175  
5/8 X 2-5/8



MU 1155  
5/8 X 1-3/4

# MOULDINGS UNLIMITED, INC.

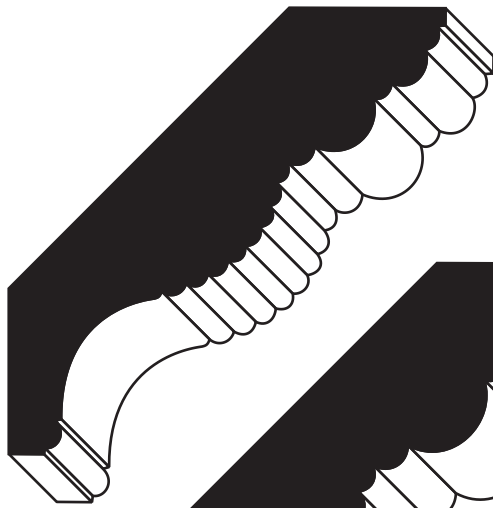

MU 2622  
CROWN  
5/8 X 3-1/4

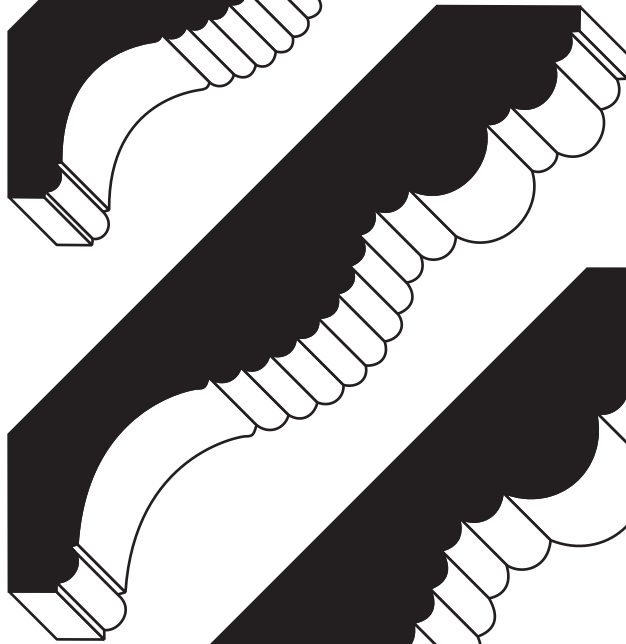

MU 2628  
CROWN  
3/4 X 4-1/4

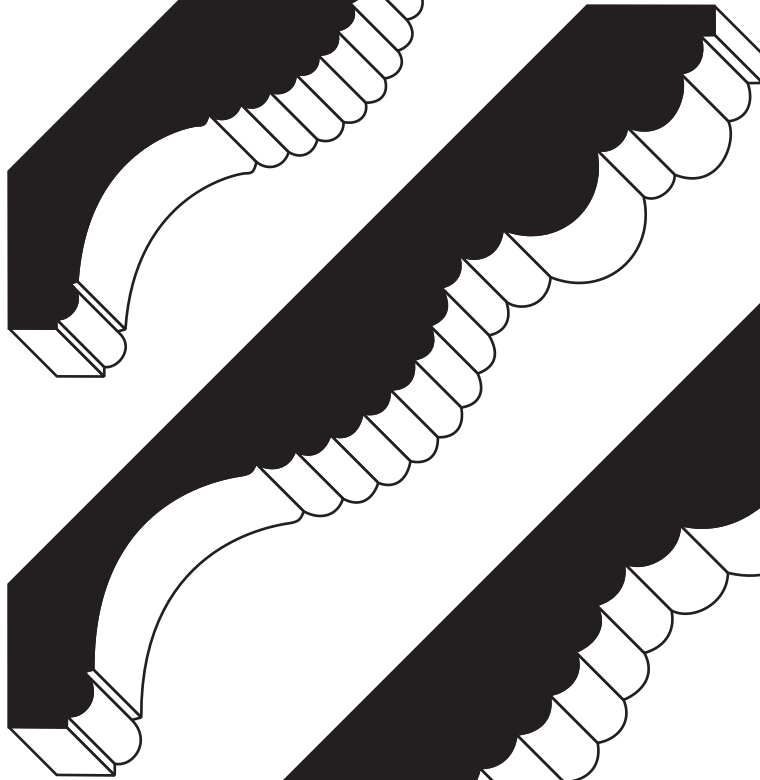

MU 2634  
CROWN  
3/4 X 5-1/4

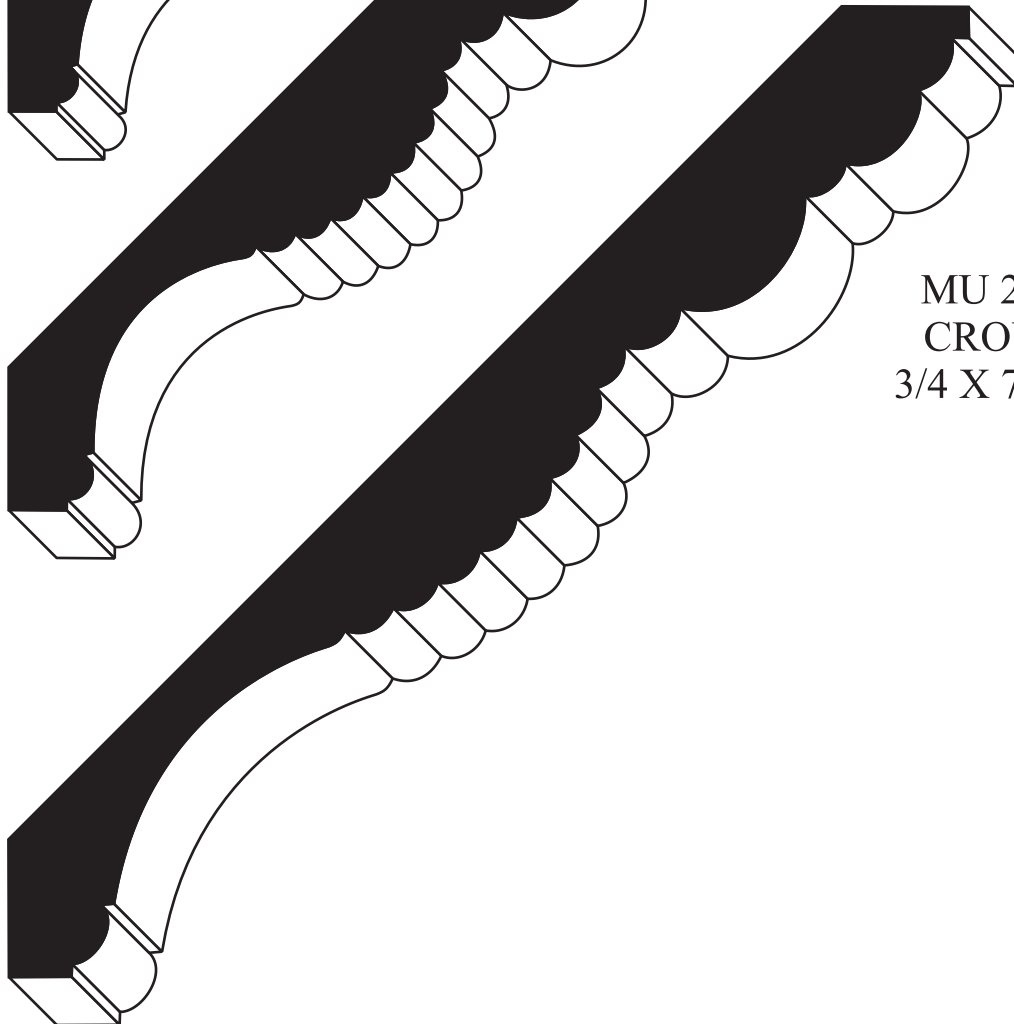

MU 2640  
CROWN  
3/4 X 7-3/16

# MOULDINGS UNLIMITED, INC.

MU 1249  
1-1/8 X 6

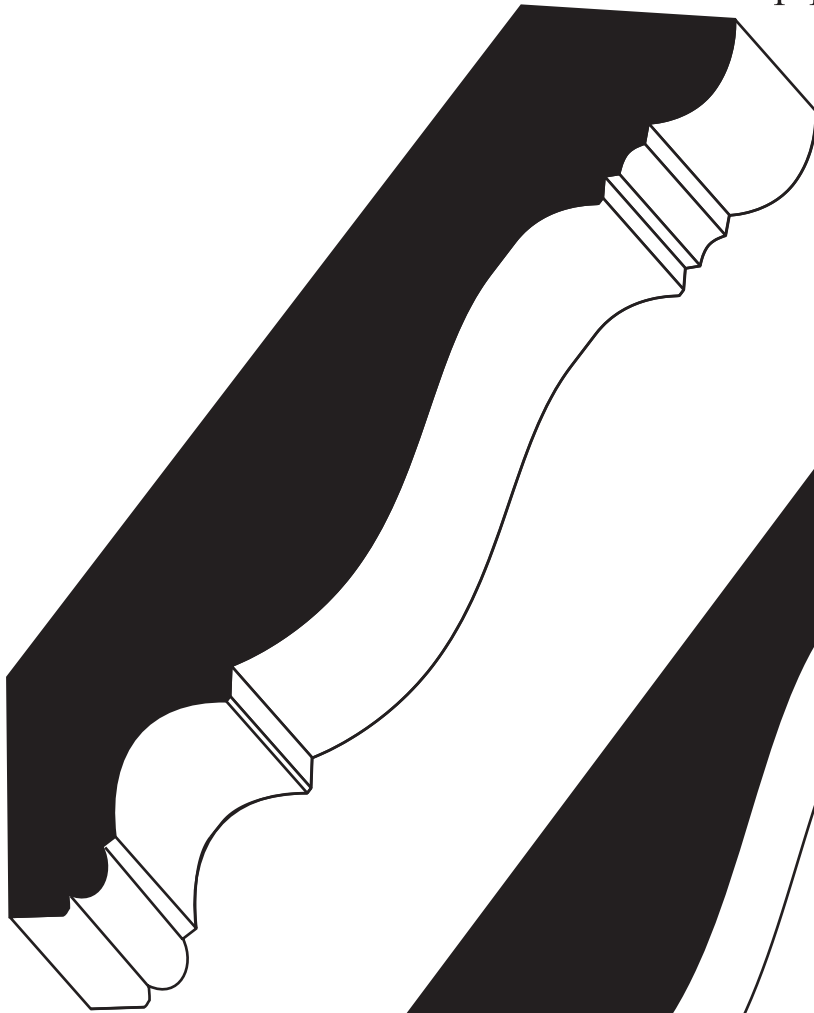

MU 1250  
1-1/8 X 8-9/16

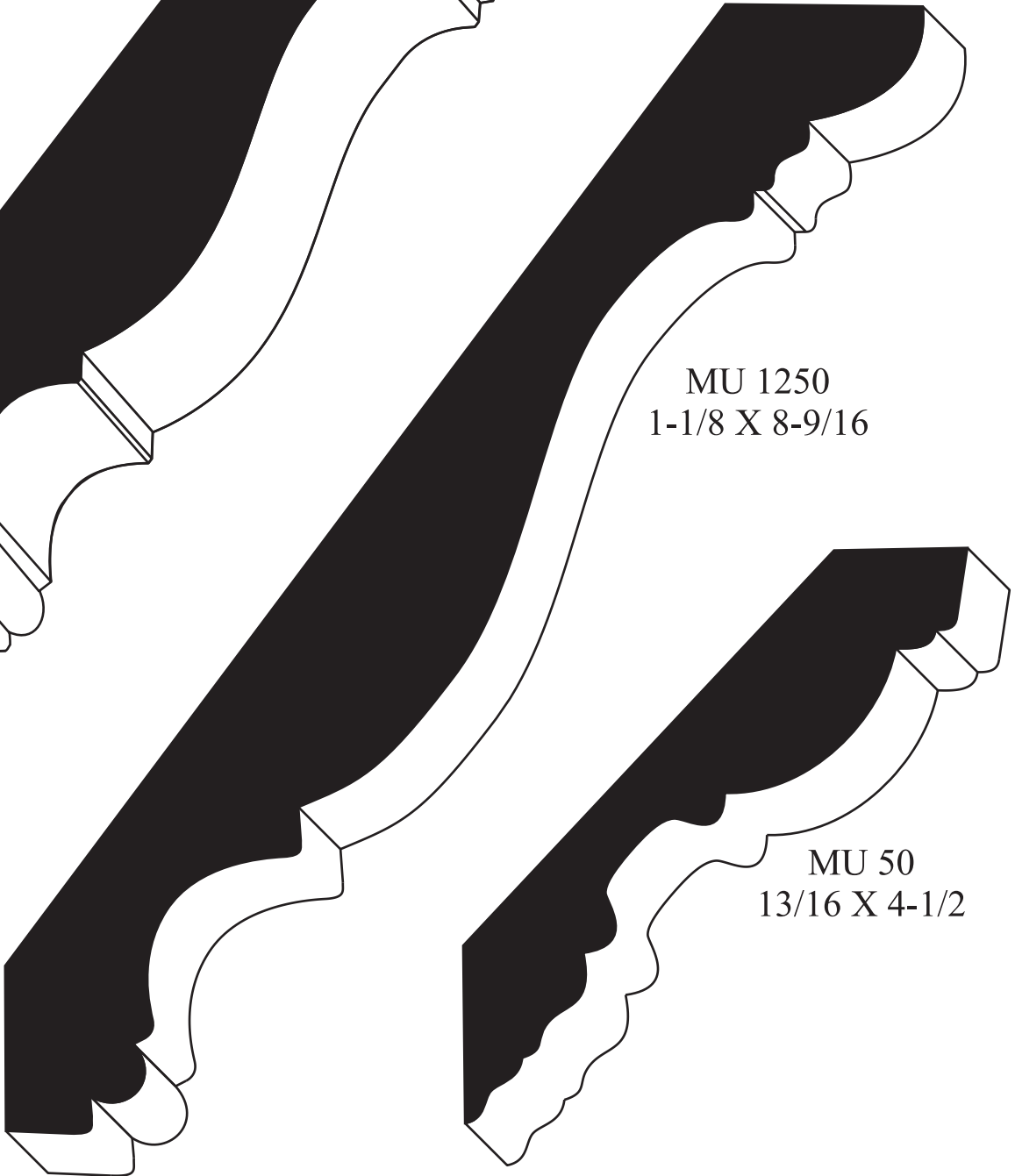

MU 50  
13/16 X 4-1/2

# MOULDINGS UNLIMITED, INC.

MU 1235  
3/4 x 3-7/8

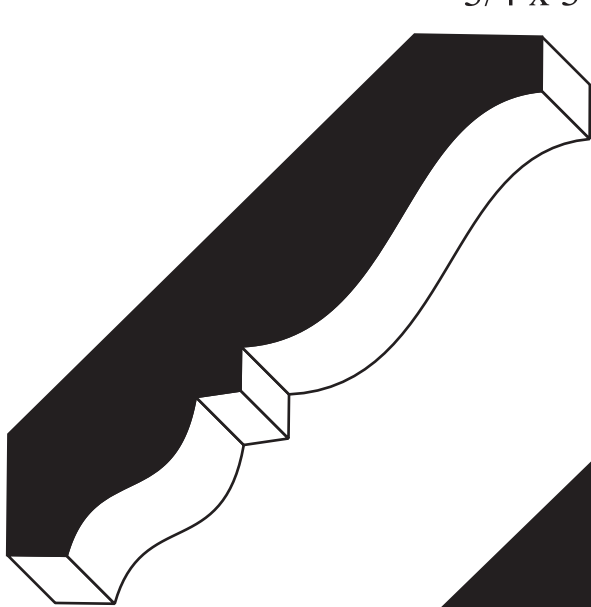

MU 1255  
1-1/16 X 8-15/16

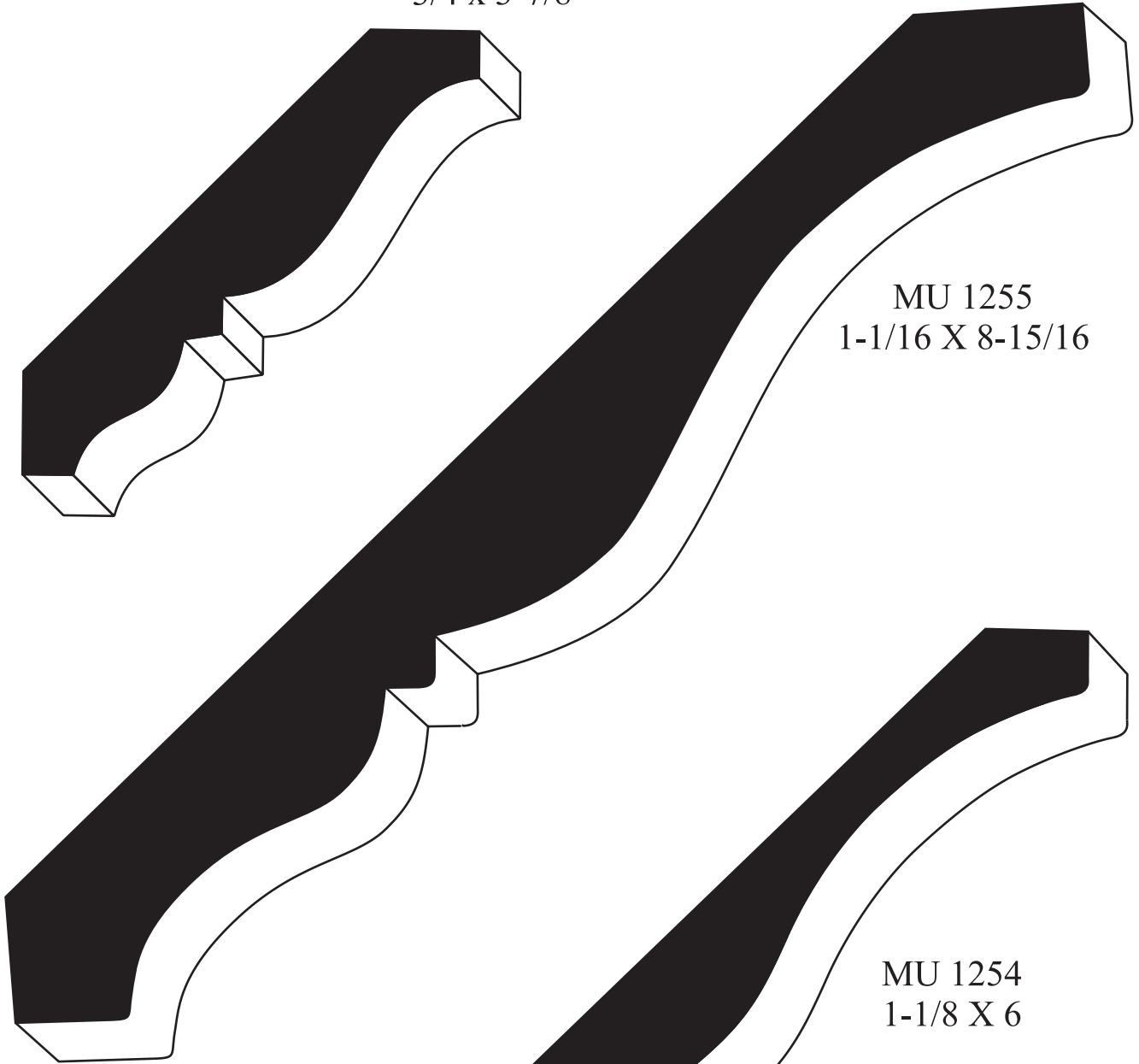

MU 1254  
1-1/8 X 6



# MOULDINGS UNLIMITED, INC.

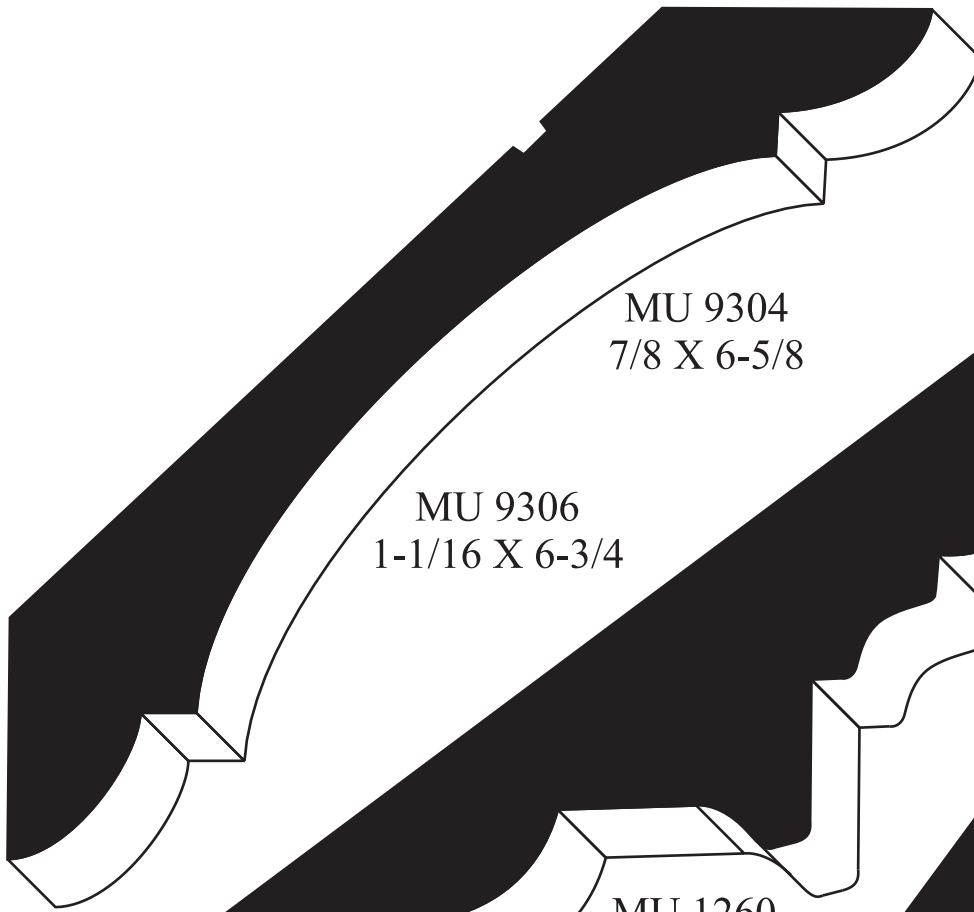

MU 9304  
7/8 X 6-5/8

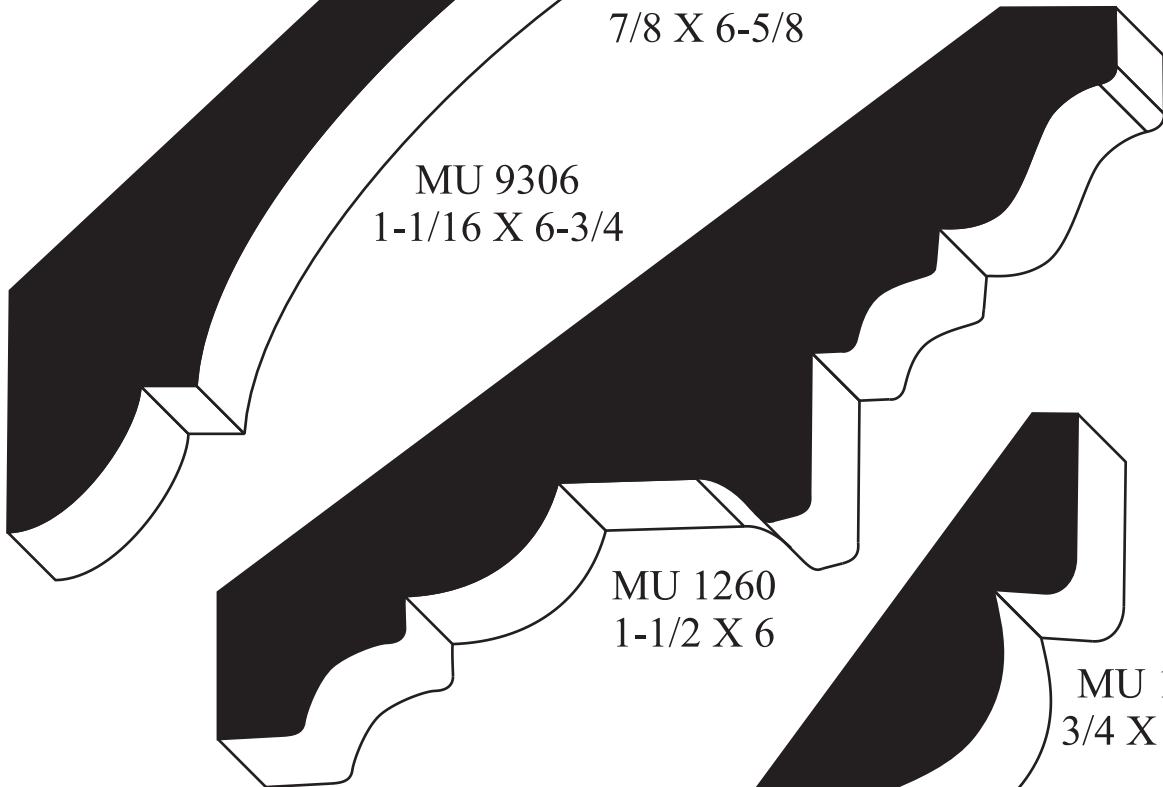

MU 9306  
1-1/16 X 6-3/4

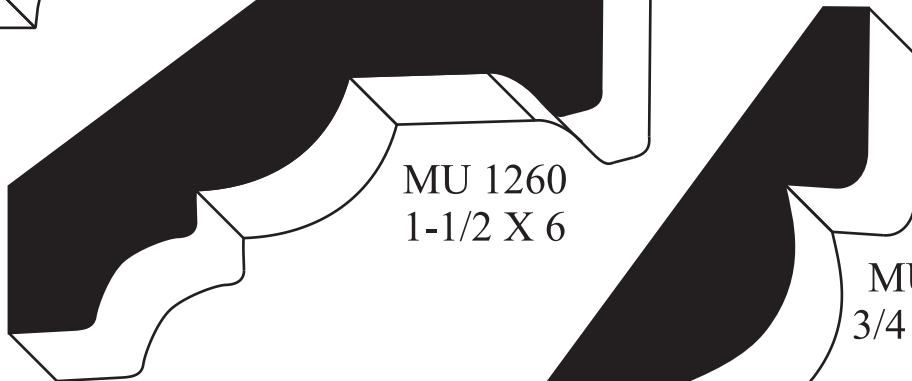

MU 1260  
1-1/2 X 6



MU 1245  
3/4 X 5-7/8

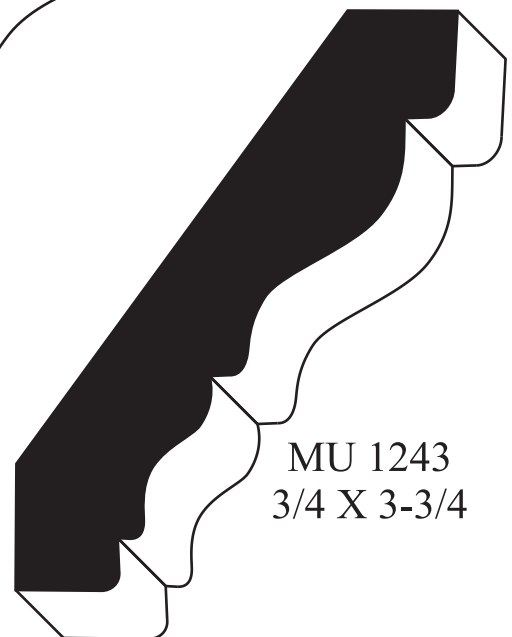

MU 1243  
3/4 X 3-3/4

# MOULDINGS UNLIMITED, INC.

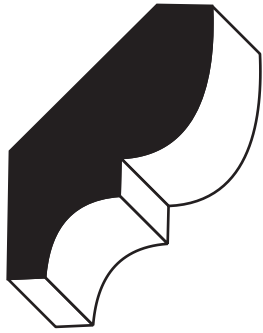

MU 74  
9/16 x 1-3/4

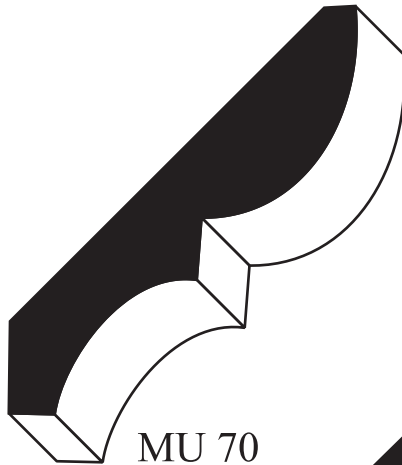

MU 70  
5/8 x 2-5/8

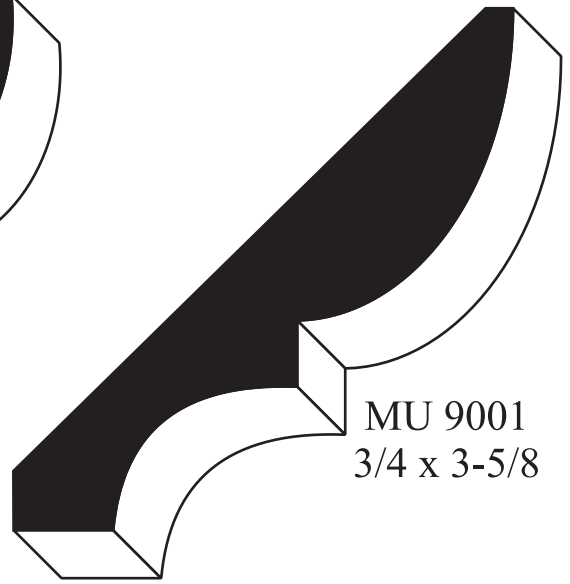

MU 9001  
3/4 x 3-5/8



MU 29  
1-1/2 x 3-1/2

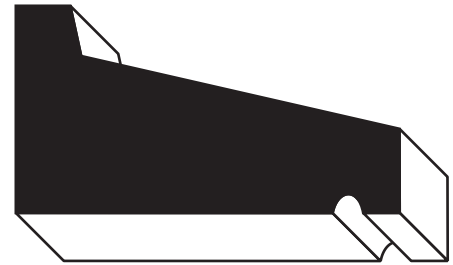

MU 187  
1-1/16 x 2



MU 180  
1-9/32 x 2

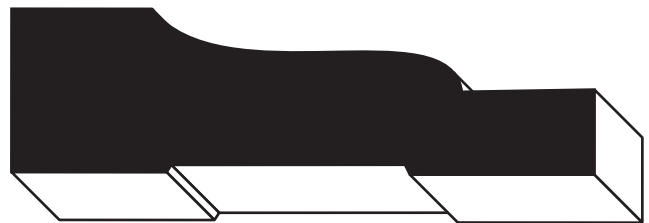

MU 28  
13/16 x 3-1/2

# MOULDINGS UNLIMITED, INC.

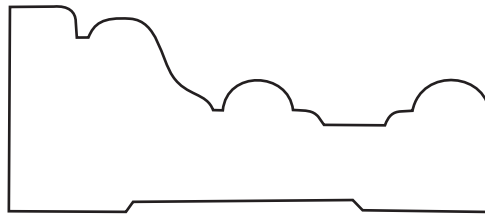

MU 2200  
1-1/32 X 2-1/2

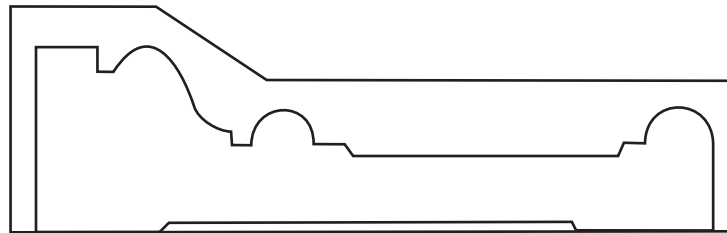

MU 3 HOWE CASING  
1-1/32 x 3-1/2

MU 27 PLINTH  
1-1/4 x 3-3/4

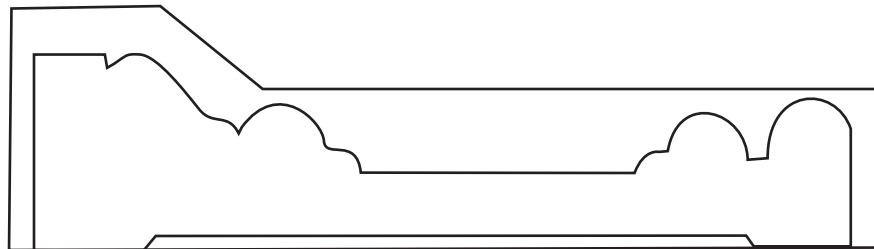

MU 3300  
1-1/32 X 4-1/4

MU 3305  
1-1/4 X 4-1/2

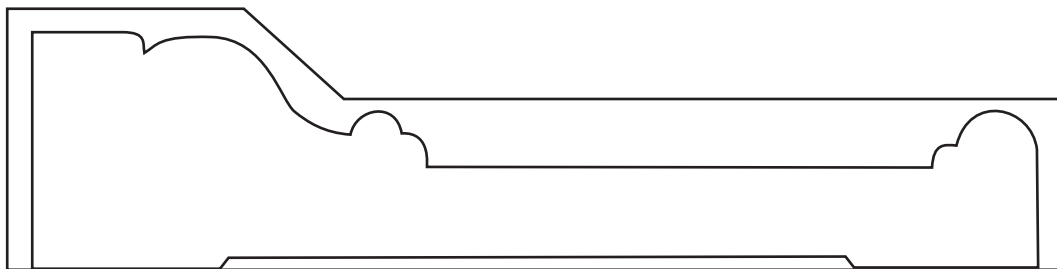

MU 3320  
1-1/4 X 5-1/4

MU 3325 Plinth  
1-3/8 X 5-1/2

# MOULDINGS UNLIMITED, INC.



MU 6900 1/2 X 1



MU 9848 3/8 x 1-1/2



MU 6901 1/2 X 1-1/4



MU 9864 3/8 x 2



MU 6902 1/2 x 1-1/2

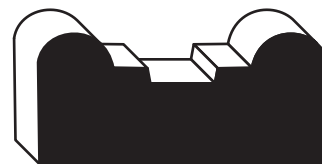

MU 2212 11/16 X 1-1/2



MU 6903 1/2 x 2



MU 2216 11/16 X 2



MU 6904 1/2 x 2-1/2



MU 2220 11/16 X 2-1/2



MU 6905 1/2 X 3



MU 2224 11/16 x 3



MU 6906 1/2 X 3-1/2



# MOULDINGS UNLIMITED, INC.

a-8809  
b-3  
c-8811

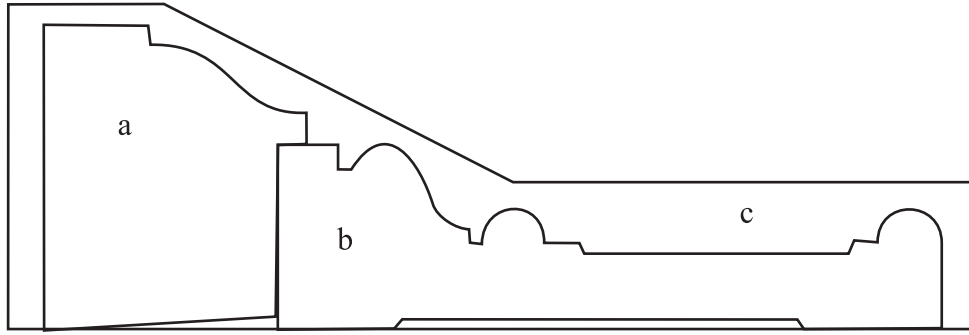

MU 8809  
BACK BAND  
1-3/8 x 1-5/8

MU 3 HOWE CASING  
1-1/32 x 3-1/2

MU 8811 PLINTH BLOCK  
1-13/16 x 5

MU 8808  
BACK BAND  
1-7/32 x 1-1/4  
MU 8801 CASING  
1/2 x 2-7/8

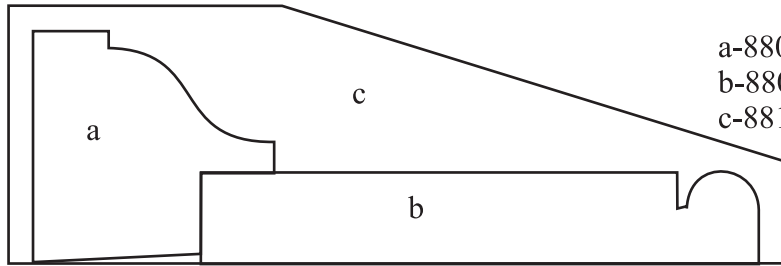

a-8808  
b-8801  
c-8810

MU 8810 PLINTH BLOCK  
1-3/8 x 4

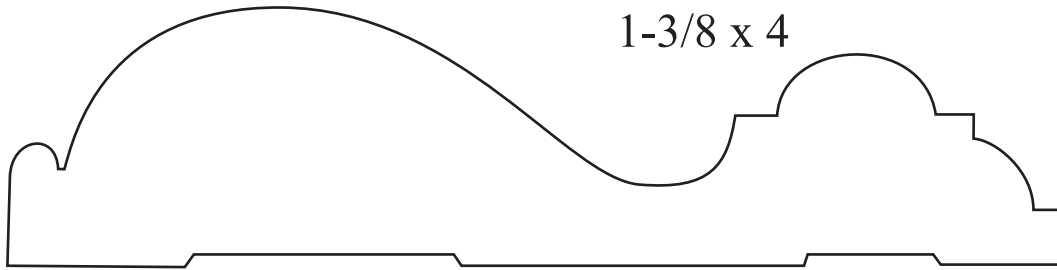

MU 20 MANTEL MOULD 1-5/16 X 5-1/2

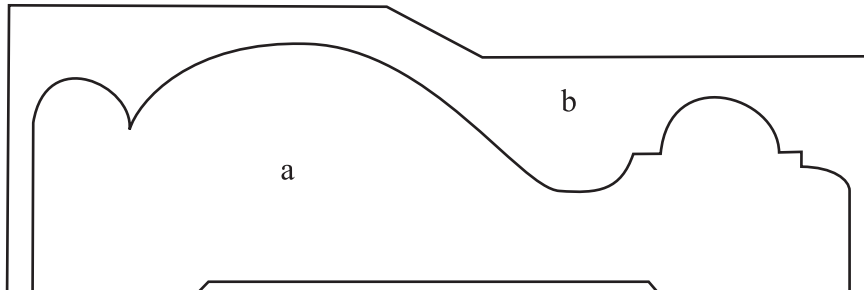

a-195  
b-197

MU 195 MANTLE MOULD 1-3/8 X 4-1/4

MU 197 PLINTH 1-1/2 X 4-1/2

# MOULDINGS UNLIMITED, INC.

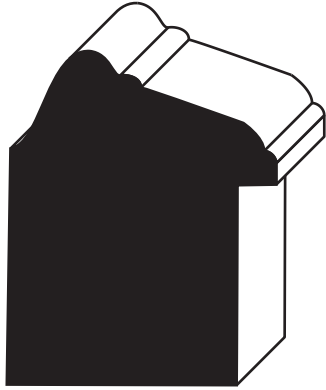

MU 8819  
1-3/4 X 1-3/8

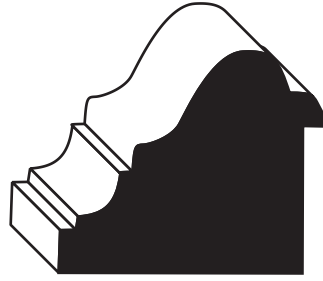

MU 44  
1-3/8 X 1-3/8



MU 8808  
1-1/4 x 1-1/4

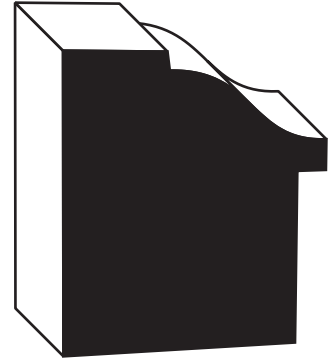

MU 8809  
1-3/8 x 1-5/8



MU 280  
11/16 x 1-1/16

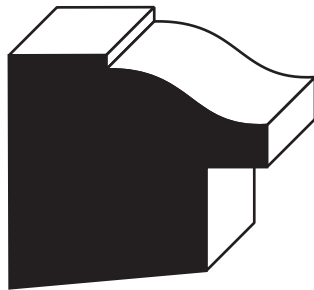

MU 281  
1-5/16 x 1-3/8



MU 371 CASING  
11/16 x 3

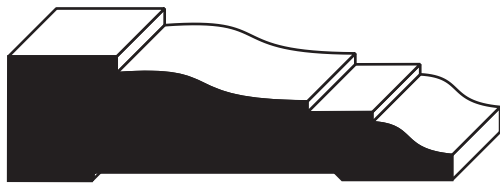

MU 366 CASING  
11/16 x 2-1/4



MU 445 CASING  
11/16 x 3-1/2

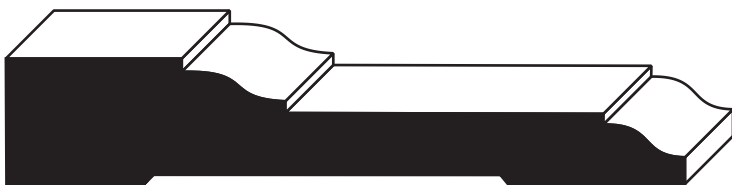

MU 8846 CASING  
11/16 x 3-1/2



MU 356 CASING  
5/8 x 2-1/4

# MOULDINGS UNLIMITED, INC.

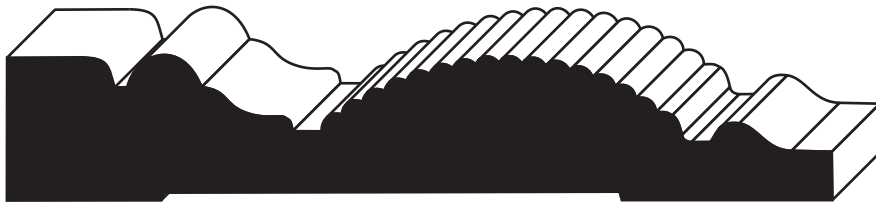

MU 2476 3/4 X 4-1/4

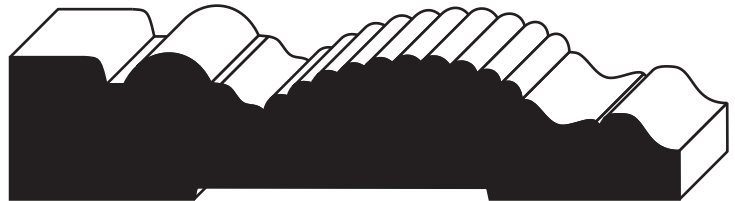

MU 2472 3/4 X 3-1/2



MU 2468 3/4 X 2-3/4



MU 6872 3/4 x 4



MU 6862 3/4 x 3



MU 6878 3/4 X 4-1/4



MU 6876 3/4 X 3-1/2

# MOULDINGS UNLIMITED, INC.



MU 4801 1-1/16 x 4-1/4

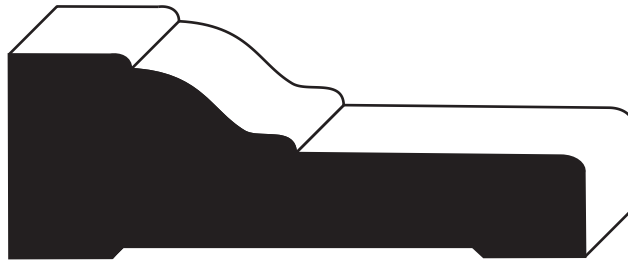

MU 4710 1-1/16 X 3

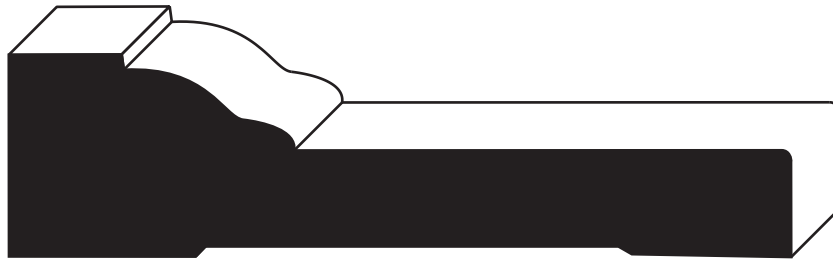

MU 4713 1-1/16 x 4

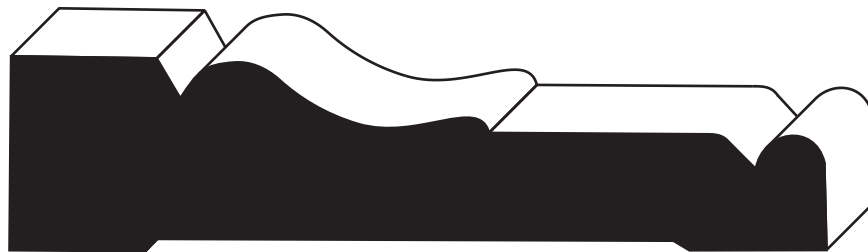

MU 4725 1 X 4-1/4



MU 4750 1-1/4 X 4-1/2

# MOULDINGS UNLIMITED, INC.



MU 5985 3/4 X 3-1/2

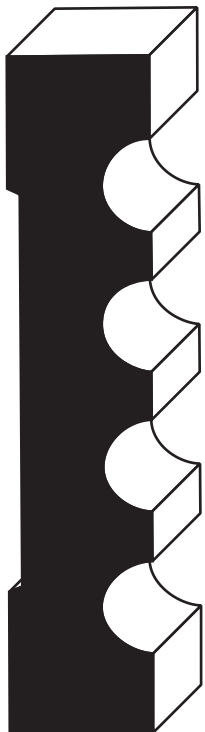

MU 5965 3/4 X 3-1/2



MU 5478 3/4 X 5-1/2

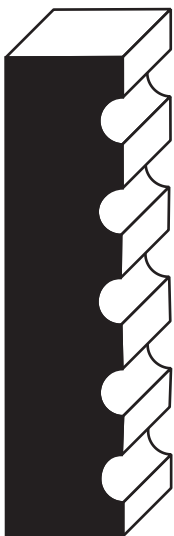

MU 5663 5/8 X 2-1/2



MU 5488 3/4 X 7-1/2



MU 5498 3/4 X 9-1/4

# MOULDINGS UNLIMITED, INC.



MU 7695 3/4 x 3-1/2



MU 7685 3/4 x 2-1/2



MU 7301 3/4 X 4-1/2

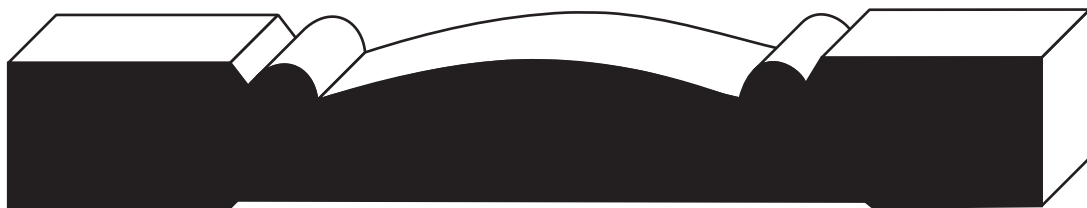

MU 4248 3/4 X 5-3/8



MU 4448 3/4 X 5-3/8

# MOULDINGS UNLIMITED, INC.



MU 1187 11/16 X 2-3/4



MU 1364 3/4 X 3



MU 39 WINDOW STOOL 3/4 X 5-1/4

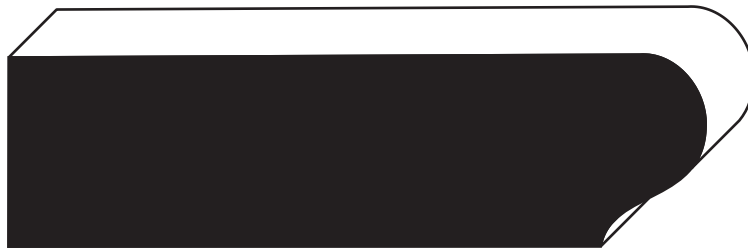

MU 1362 1 X 3-5/8



MU 239 WINDOW STOOL 1 X 5-1/2

# MOULDINGS UNLIMITED, INC.



MU 2150 1-1/4 X 4-9/16



MU 2152 1-1/4 X 6-9/16

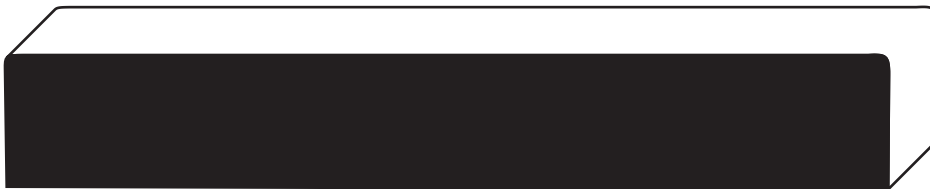

MU 2151 3/4 X 4-9/16



MU 2153 3/4 X 6-9/16



# MOULDINGS UNLIMITED, INC.



MU 3462  
3/4 X 5-1/4

MU 3472  
3/4 X 6-1/4

MU 3482  
3/4 X 7-1/4

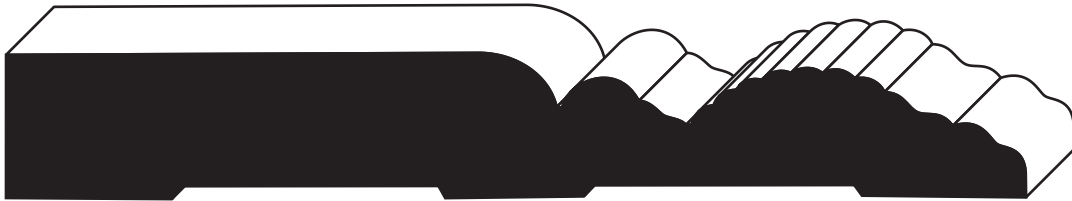

MU 3000  
3/4 X 5-1/4

MU 3002  
3/4 X 6-1/4

MU 3004  
3/4 x 7-1/4

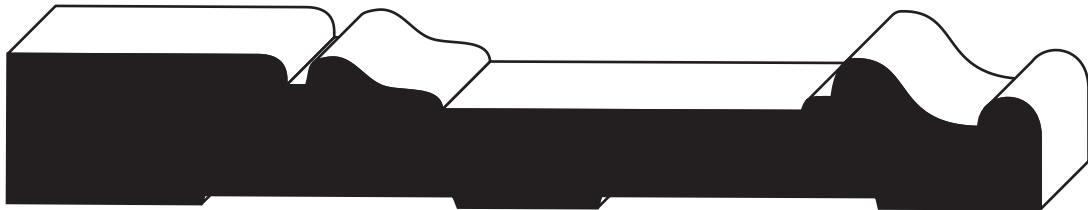

MU 3678 3/4 X 5-1/4



MU 3372  
3/4 X 4-1/4

MU 3374  
3/4 X 5-1/4

MU 3376  
3/4 X 6-1/4

MU 3378  
3/4 X 7-1/4

MU 3382  
3/4 x 9-1/4

MU 3384  
3/4 x 11-1/4



MU 623  
9/16 X 3-1/4

MU 620  
9/16 X 4-1/4

MU 618  
9/16 X 5-1/4

# MOULDINGS UNLIMITED, INC.



MU 6248 3/4 X 3



MU 1567 3/4 X 2-7/8

## CHAIR RAILS



MU 8806 1-1/16 X 2-1/2

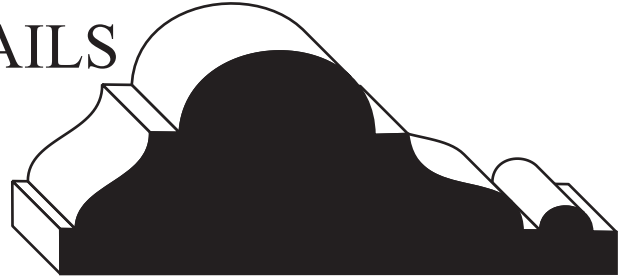

MU 8807 1-3/16 X 2-15/16



MU 2904 1-3/16 X 3-1/4



MU 1910 3/4 X 1-1/2

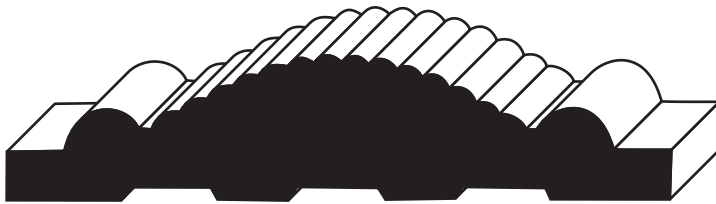

MU 1577 3/4 X 3-1/2

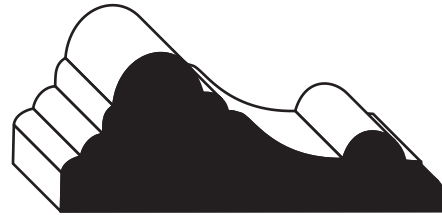

MU 1912 3/4 X 2

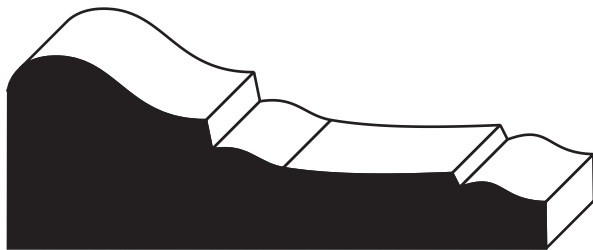

MU 1905 1-1/16 X 2-3/4



MU 1001 3/4 X 2-3/4

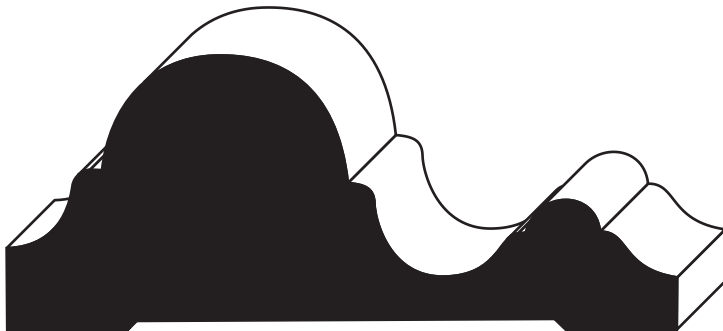

MU 1305 1-7/16 X 3-1/2



MU 1303 1-1/4 X 2-7/8

# MOULDINGS UNLIMITED, INC.



MU 7787 1 X 3-1/4



MU 7791 11/16 X 2-5/8

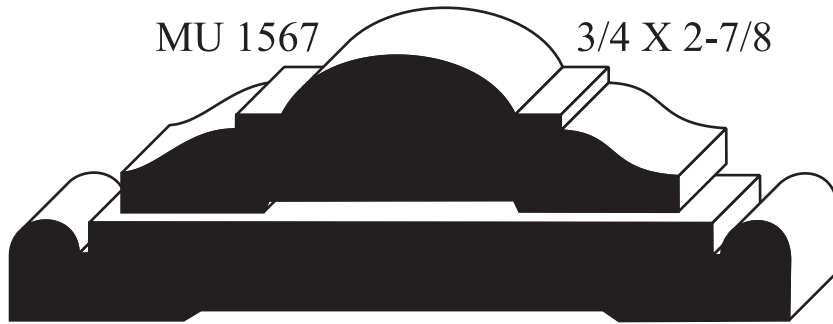

MU 1567 3/4 X 2-7/8



MU 8803 CHAIR RAIL 1/2 X 4-1/8



MU 8802 CHAIR RAIL 1/2 X 5-3/8



MU 8822 CHAIR RAIL 3/4 X 6



MU 804 CHAIR RAIL 3/4 X 4-7/8

# MOULDINGS UNLIMITED, INC.

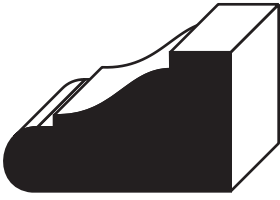

MU 5  
CAP MOULD  
3/4 X 1-1/8

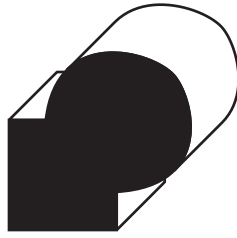

MU 8812  
PENCIL MOULD  
3/4 X 3/4



MU 8042  
3/8 X 3/4



MU 8142  
1/2 X 1-1/8



MU 8193  
9/16 X 1

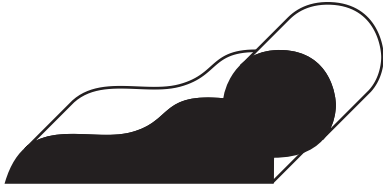

PICTURE MOULD  
MU 295  
3/4 X 1-3/4

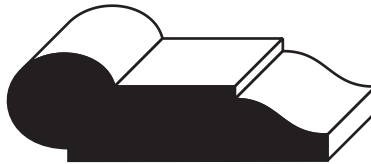

MU 273  
5/8 X 1-3/4



MU 8194  
3/4 X 1-1/4

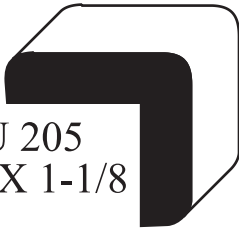

MU 205  
1-1/8 X 1-1/8



MU 206  
11/16 X 11/16



MU 8195  
13/16 X 1-11/16

## HALF ROUND



MU 124  
1/4 X 1/2



MU 122  
3/8 X 3/4



MU 222  
1/2 X 1



MU 9101  
3/4 X 1-1/2



MU 9897  
SCRIBE  
3/8 X 3/4



MU 842  
1/4 X 1-1/4



MU 142  
1/4 X 3/4

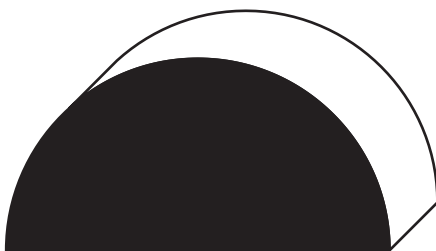

MU 9142  
1 X 2

## SCREEN MOULD



MU 144  
3/8 X 1-1/8

# MOULDINGS UNLIMITED, INC.



MU 820  
3/8 X 7/8



MU 816  
3/8 X 1-3/8



MU 34  
1/2 X 2



MU 941  
3/8 X 3/4

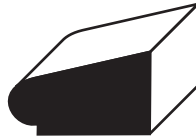

MU 152  
3/8 X 3/4



MU 111  
3/8 X 3/8



MU 940  
3/8 X 7/8



MU 14  
3/8 X 3/8



MU 108  
1/2 X 1/2



MU 938  
3/8 X 1-1/8



MU 15  
1/2 X 1/2



MU 107  
5/8 X 5/8



MU 936  
3/8 X 1-3/8



MU 97  
5/8 X 5/8



MU 105  
3/4 X 3/4



MU 935  
3/8 X 1-5/8



MU 100  
3/4 X 3/4

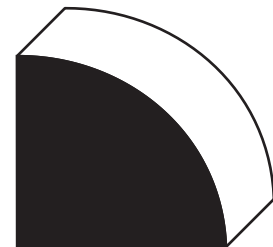

MU 103  
1-1/16 X 1-1/16

# MOULDINGS UNLIMITED, INC.

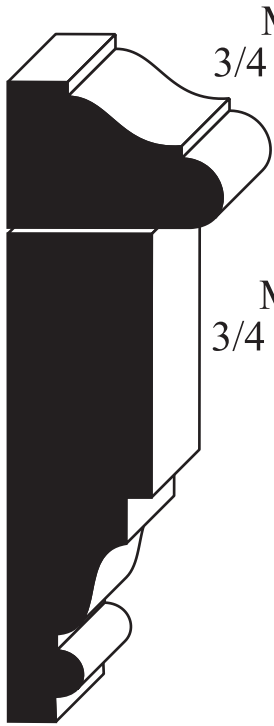

MU 5  
3/4 X 1-1/8

MU 2  
3/4 X 2-1/2

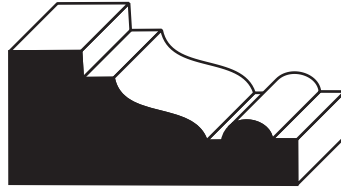

MU 1102  
5/8 X 1-1/2



MU 164  
3/8 X 3/4



MU 162  
17/32 X 13/16

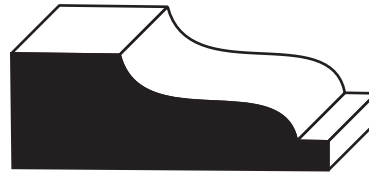

MU 1643  
9/16 X 1-5/8



MU 165  
1/2 X 1



MU 272  
1/2 X 3/4



MU 167  
5/8 X 1



MU 789  
3/4 X 1-1/4



MU 163  
5/8 X 1-3/8



MU 177  
3/4 X 1-1/8



MU 967  
3/4 X 1-1/8



MU 172  
5/8 X 3/4



MU 175  
3/4 X 7/8



MU 169  
11/16 X 1-1/4



MU 7321  
1-5/8 X 1-1/4



MU 1301  
3/4 X 1-3/4



MU 7481  
3/4 X 1-1/8

# MOULDINGS UNLIMITED, INC.



MU 894  
11/16 X 7/8

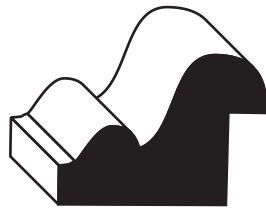

MU 896  
3/4 X 1-1/8



MU 1279  
3/4 X 2-3/8



MU 9402  
3/4 X 2



MU 1281  
1 X 3  
3/4 rabbets



MU 9102  
3/4 X 2-15/16



MU 44  
1-3/16 X 1-3/16  
3/4 rabbet



MU 1273  
3/4 X 1-5/8  
1/2 rabbet



MU 1277  
5/8 X 1-3/4  
1/2 rabbet

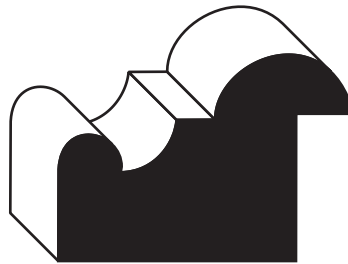

MU 4224  
1-1/16 X 1-5/8  
3/4 rabbet



MU 1275  
3/4 X 1-5/8  
1/4 rabbet



MU 43  
1-1/16 X 2  
3/4 rabbet



MU 42  
1-1/16 X 1-5/8



MU 1271  
3/4 X 1-5/8



MU 41  
3/4 X 2

# MOULDINGS UNLIMITED, INC.



MU 2191 3/8 X 3-1/4



MU 2193 3/8 X 3-1/4



MU 2180 5/8 X 3-1/4



MU 2182 5/8 X 3-1/4



MU 2184 5/8 X 5-1/4



MU 2185 5/8 X 5-1/4



MU 2189 3/4 X 5-3/8



MU 2107 5/8 X 5-1/4



# MOULDINGS UNLIMITED, INC.

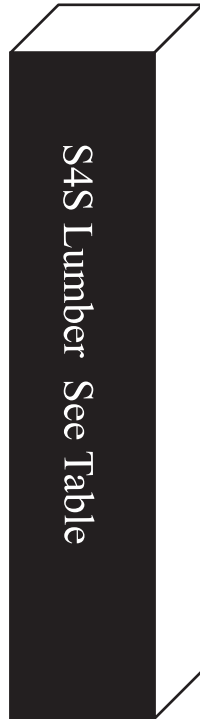
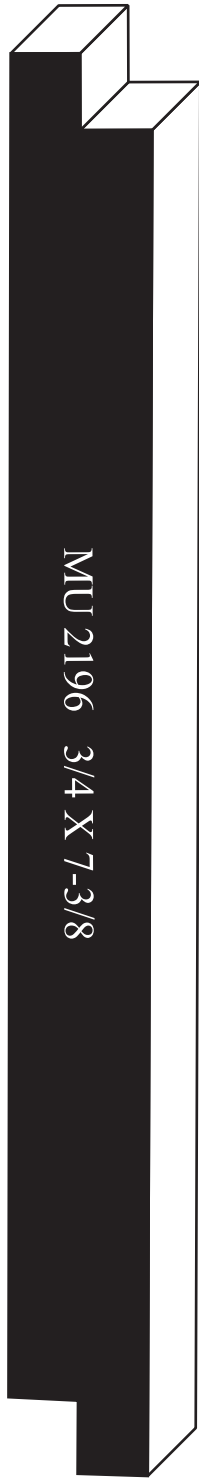

## S4S Lumber

MU 2024 3/4 X 1-1/2

MU 2032 3/4 X 2

MU 2040 3/4 X 2-1/2

MU 2048 3/4 X 3

MU 2056 3/4 X 3-1/2

MU 2072 3/4 X 4-1/2

MU 2088 3/4 X 5-1/2

MU 2120 3/4 X 7-1/2

MU 2144 3/4 X 9-1/4

MU 2148 3/4 X 11-1/4

S4S Lumber is surfaced on all four sides, sanded on two faces, and is stocked in the common cabinet species.

# MOULDINGS UNLIMITED, INC.

MU 23  
1-1/4 X 4-1/4

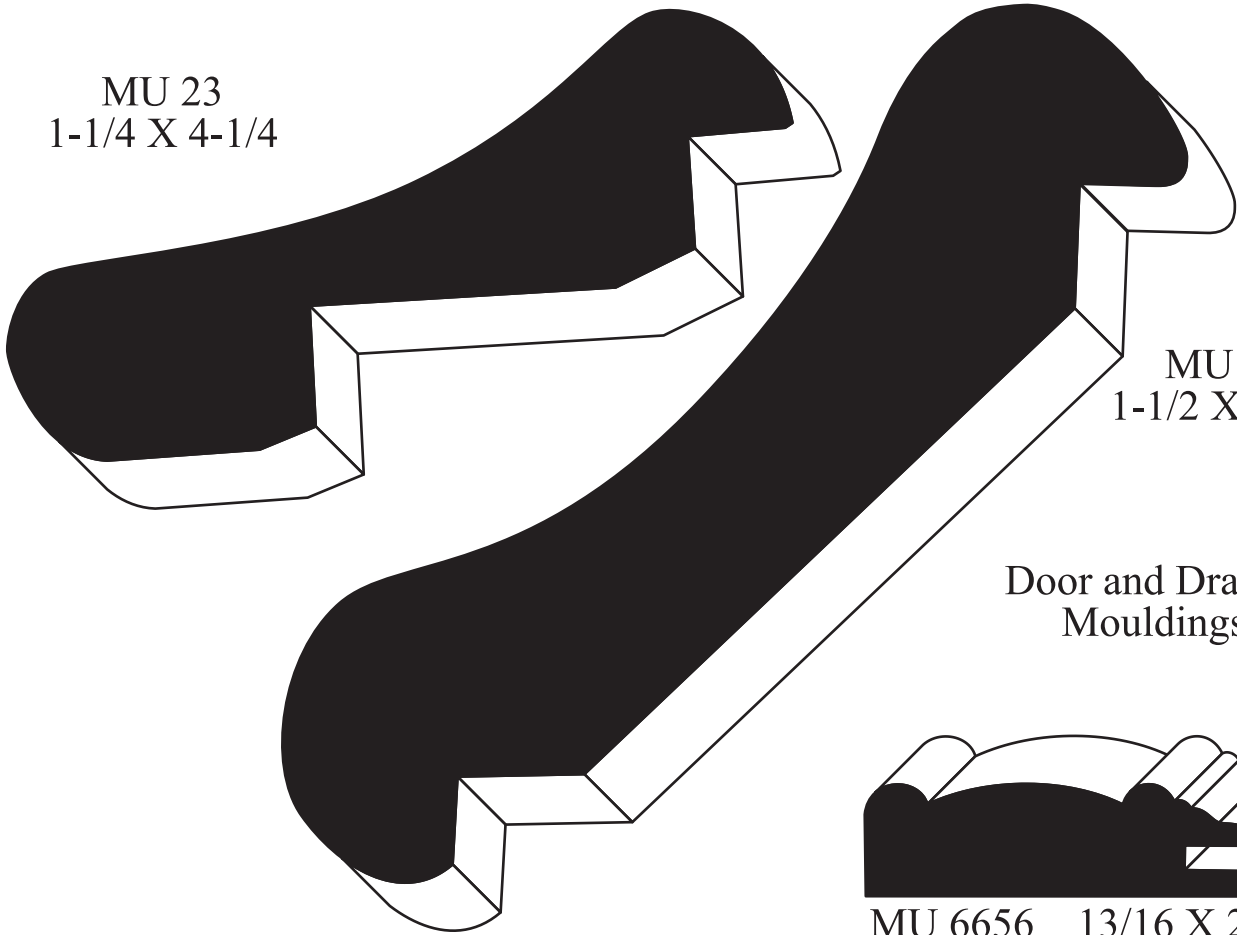

MU 25  
1-1/2 X 5-7/8

## Door and Drawer Mouldings

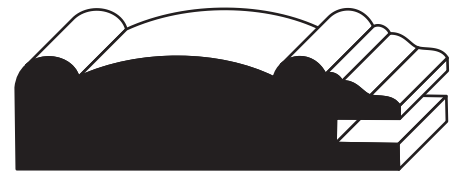

MU 6656 13/16 X 2

MU 6655 3/4 X 2-1/2

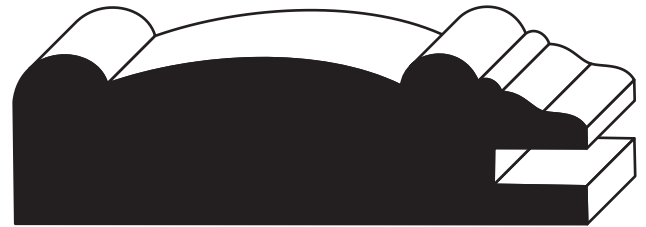
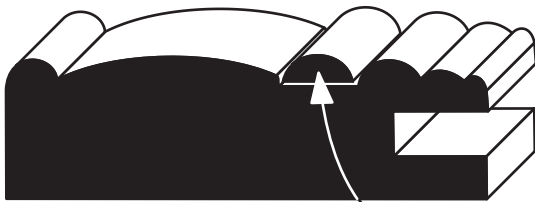

MU 6657 13/16 X 3

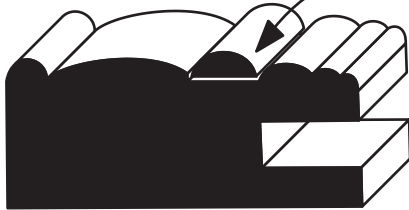

MU 6653 3/4 X 1-3/4



MU 900  
3/8 ROPE

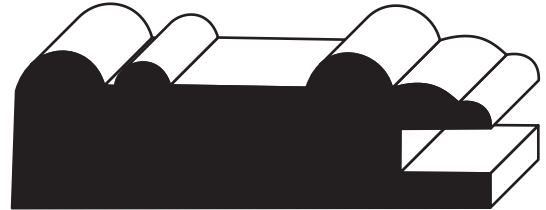

MU 6630 13/16 X 2-1/2

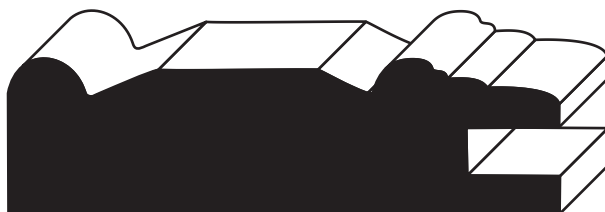

MU 6650 13/16 X 2-7/8



MU 6620 13/16 X 1-3/4

# MOULDINGS UNLIMITED, INC.



MU 3809  
1/4 X 1-1/2



MU 3840  
3/4 X 2-1/4



MU 3811  
5/16 X 1-1/2

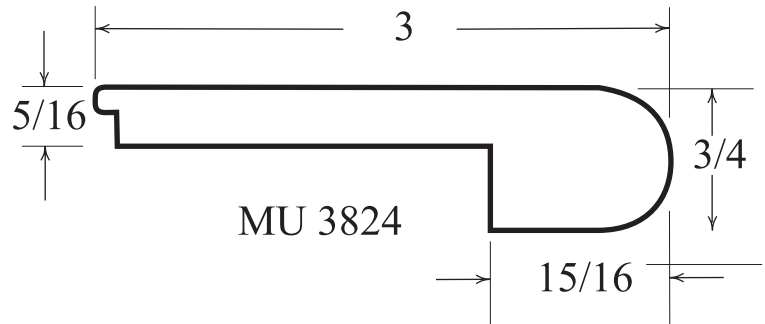

MU 3824



MU 3813  
3/8 X 1-1/2

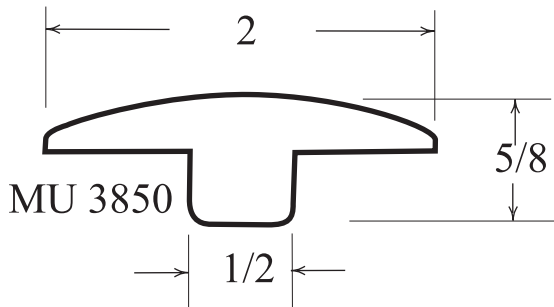

MU 3850

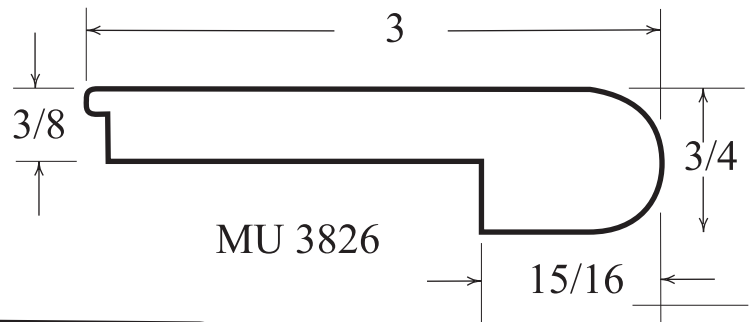

MU 3826

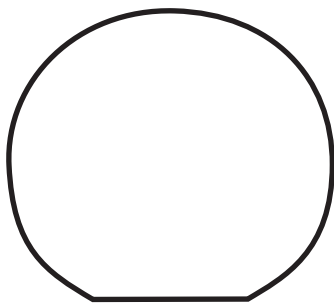

MU 2267  
1-1/2 X 1-5/8

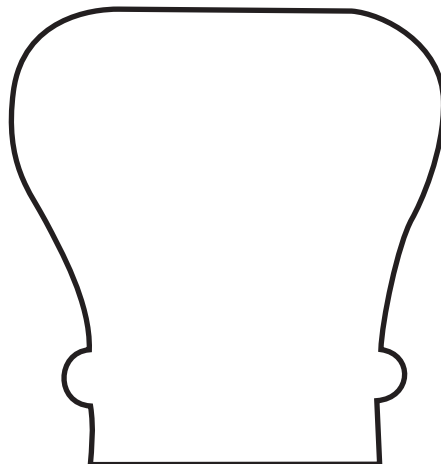

MU 2265  
2-3/8 X 2-1/4

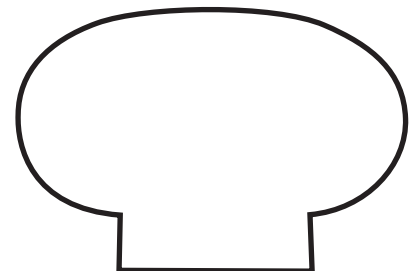

MU 2260  
1-3/8 X 2

MOULDINGS UNLIMITED, INC.



MU 3801  
FLOORING REDUCER  
1/2 X 2



MU 3804  
BABY THRESHOLD  
11/16 X 2



MU 3807  
FLOORING REDUCER 3/4 X 2-1/4



MU 3810  
T-STRIP 3/8 X 2



MU 3812  
FLOORING REDUCER  
5/16 X 1-1/2



MU 3820  
SPLINE  
1/4 X 7/16



MU 3814  
MINI THRESHOLD  
5/16 X 1-1/2



MU 3815 LANDING TREAD  
1-1/16 X 5-1/2

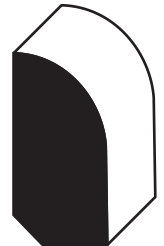

MU 129  
1/2 X 1



MU 3818 LANDING NOSING  
1-1/16 X 3-1/2



MU 105  
3/4 X 3/4

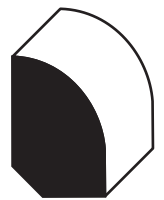

MU 127  
1/2 X 3/4



MU 3880  
STEP TREAD

1 X 11-1/2

# MOULDINGS UNLIMITED, INC.

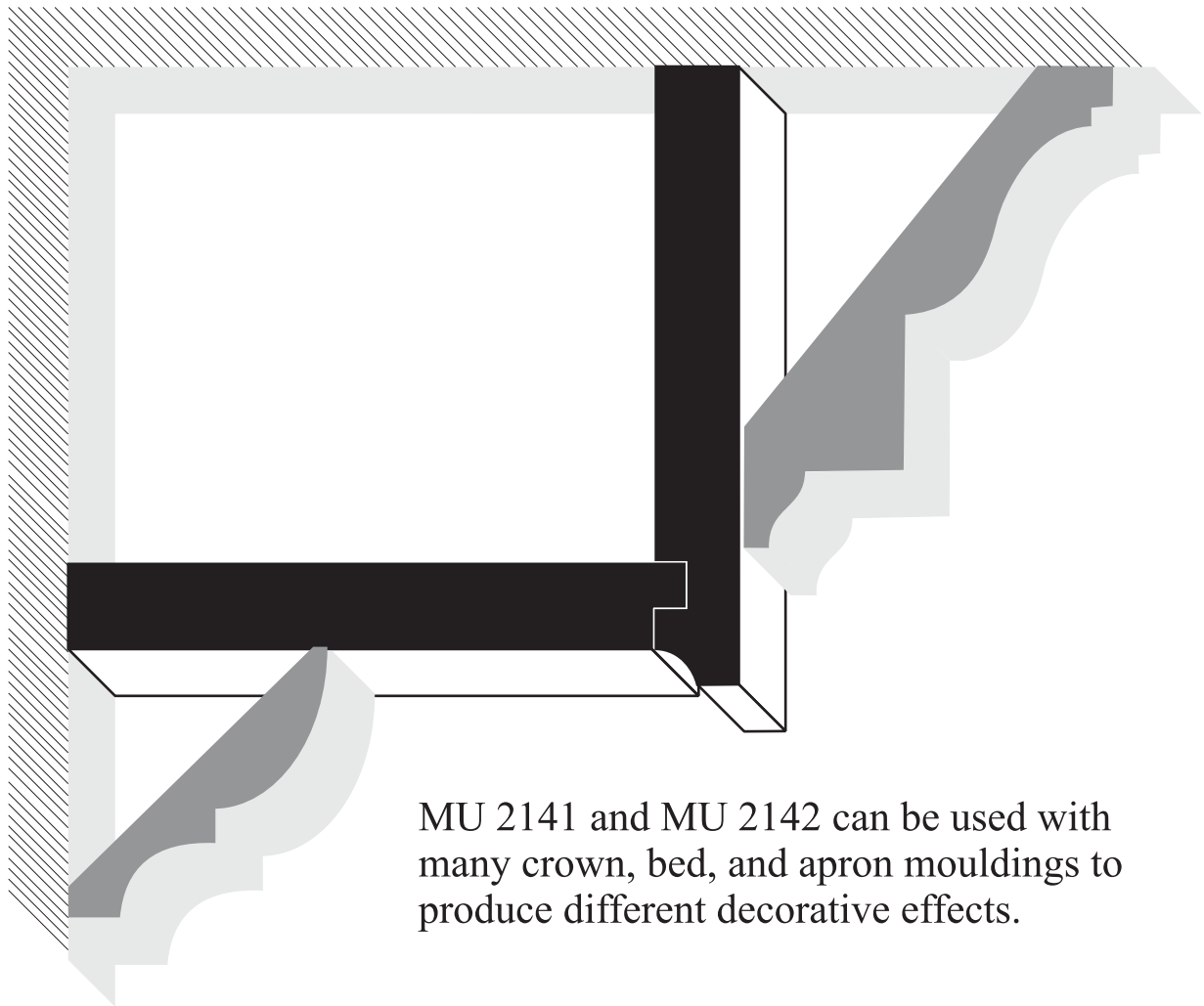

MU 2141 and MU 2142 can be used with many crown, bed, and apron mouldings to produce different decorative effects.



MU 2141 3/4 X 5-1/2



MU 2142 3/4 X 5-1/2

# MOULDINGS UNLIMITED, INC.



MU 7475 1/2 x 2



MU 7485 1/2 x 2-3/4



MU 8905 1/2 X 2



MU 2369 1/2 X 2-1/4



MU 2375 3/4 X 3-1/2

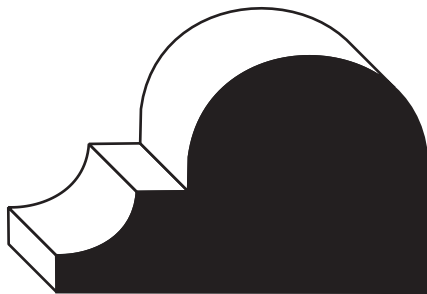

MU 7483  
1-5/16 X 1-15/16

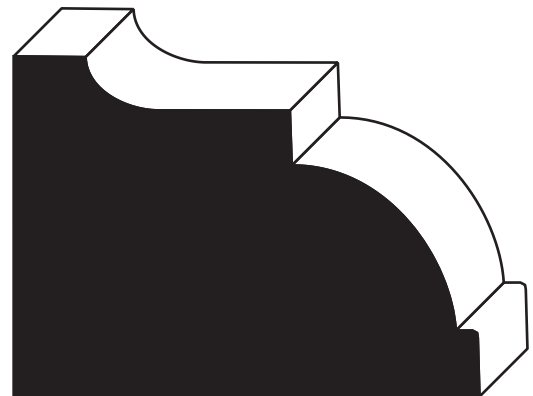

MU 7687  
2-3/8 X 1-3/4

# MOULDINGS UNLIMITED, INC.

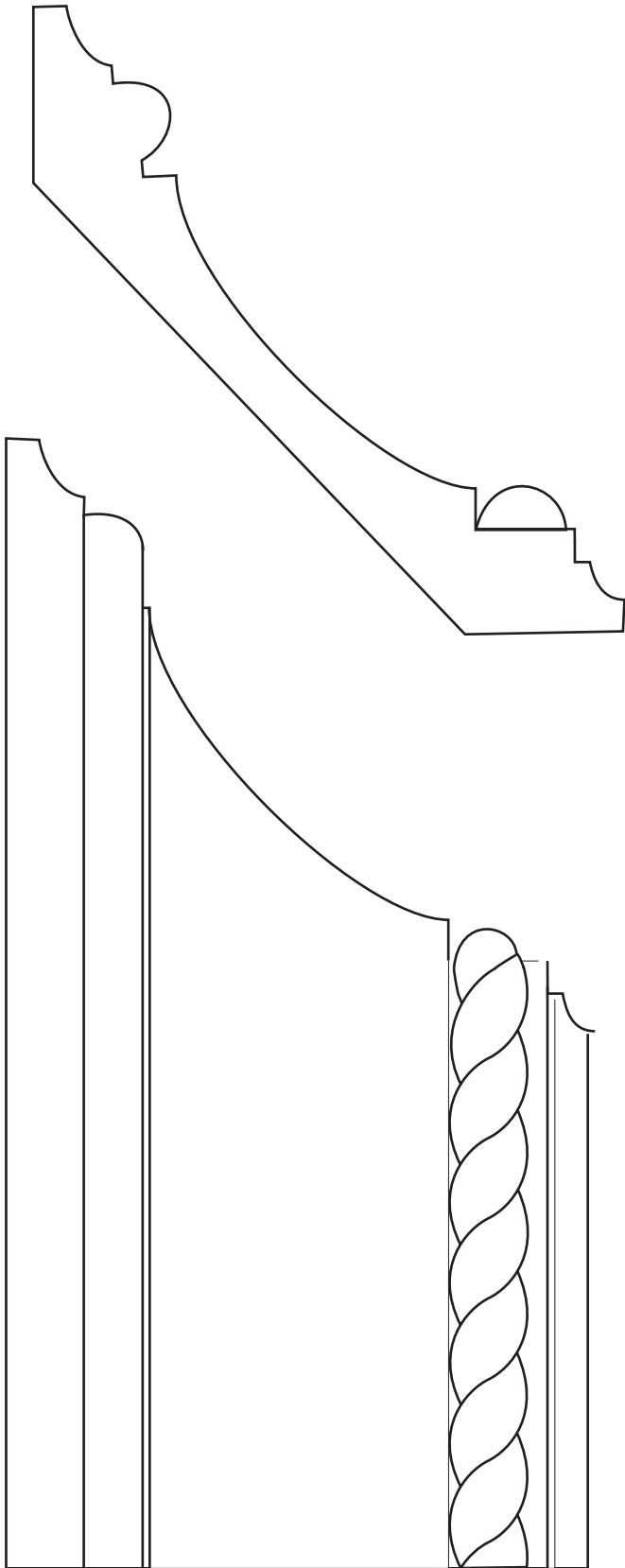

MU 6318 7/8 X 4-3/4



MU 6325  
1-1/4  
X 2-3/4



MU902 1/2 in Rope Moulding

# MOULDINGS UNLIMITED, INC.

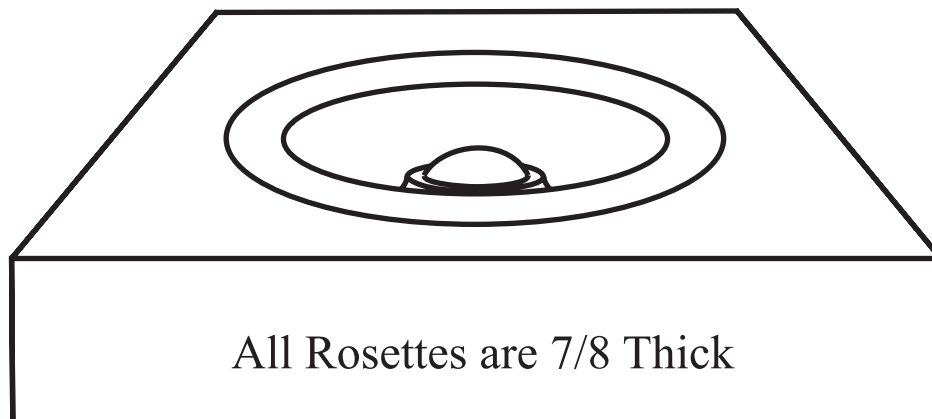
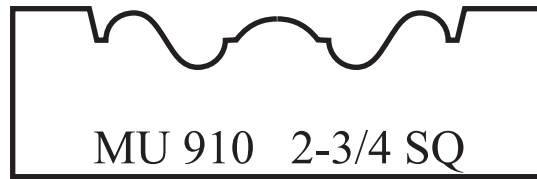



# MOULDINGS UNLIMITED, INC.

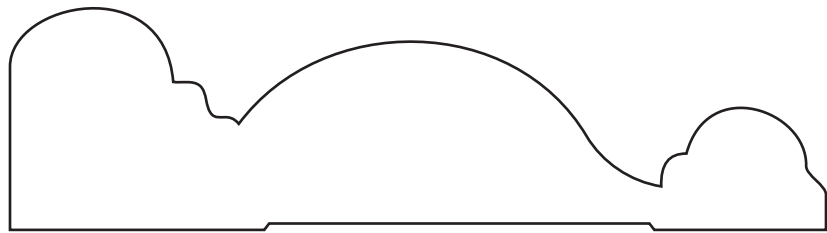

MU PP07 1-3/16 X 4-1/4

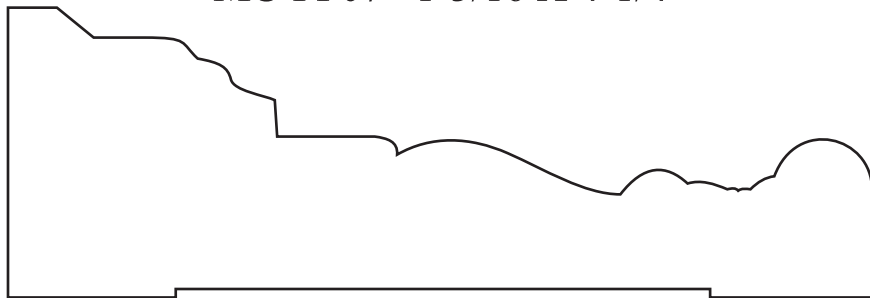

MU PP05 1-1/2 X 4-1/2

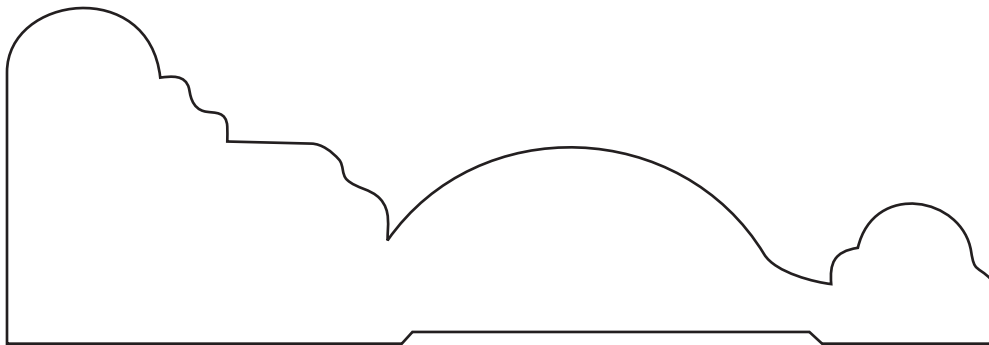

MU PP06 1-3/4 X 5-1/8

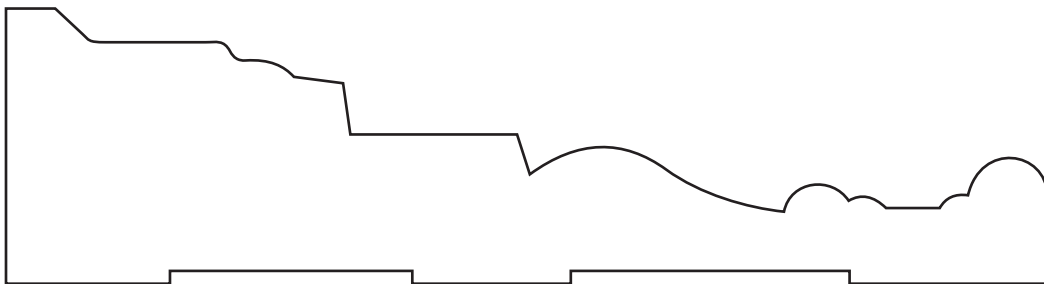

MU PP04 1-1/2 X 5-7/16

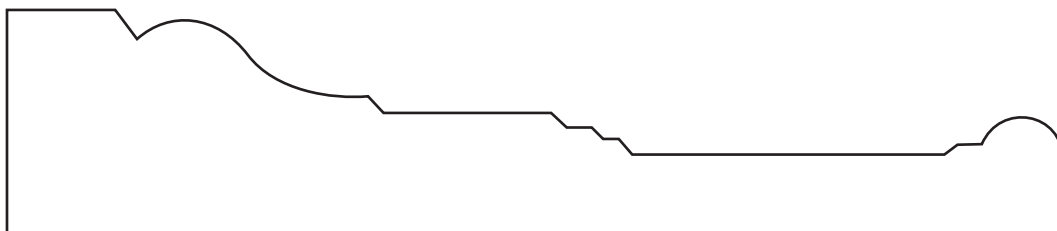

MU PP01 1-1/4 X 5-1/2

# MOULDINGS UNLIMITED, INC.



MU 4749  
1 X 3



MU 4748  
5/8 X 2-1/2

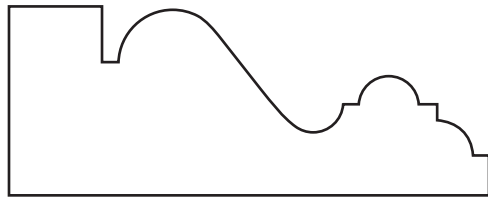

MU 9939  
1-1/16 X 2-5/8

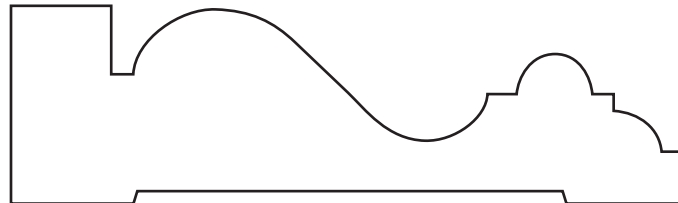

MU 9947  
1-1/16 X 3-1/2

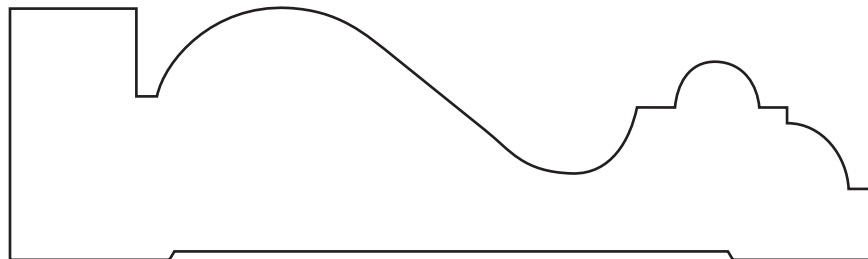

MU 9827  
1-5/16 X 4-1/2

# MOULDINGS UNLIMITED, INC.

MU 68-E  
4 SIZES  
4-1/2  
5-1/2  
6-1/2  
7-1/2

MU 65-B  
4 SIZES  
4-1/4  
5-1/4  
6-1/4  
7-1/4

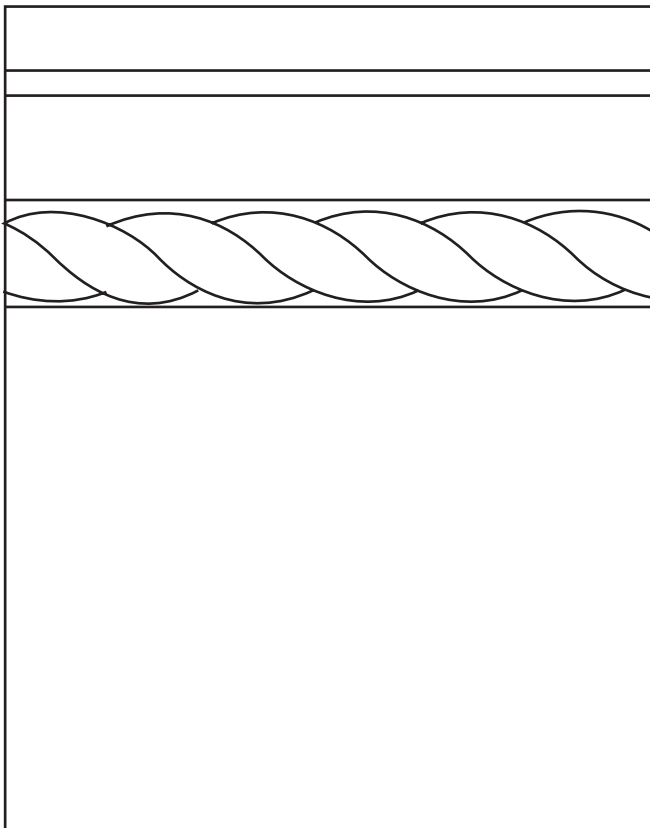

MU 6327

11/16 X 5-1/4

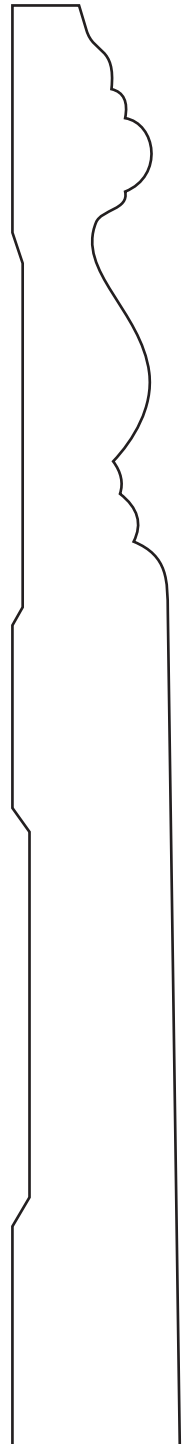
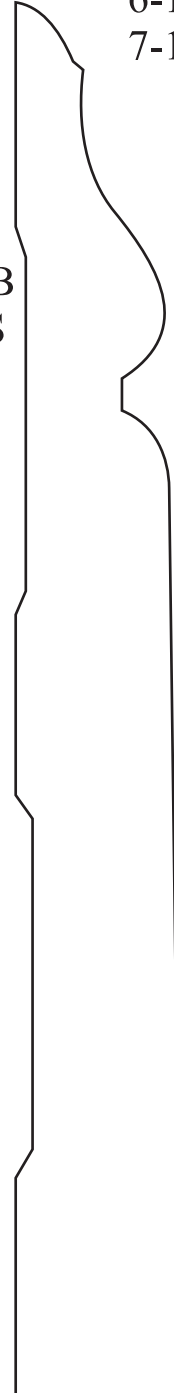

# MOULDINGS UNLIMITED, INC.

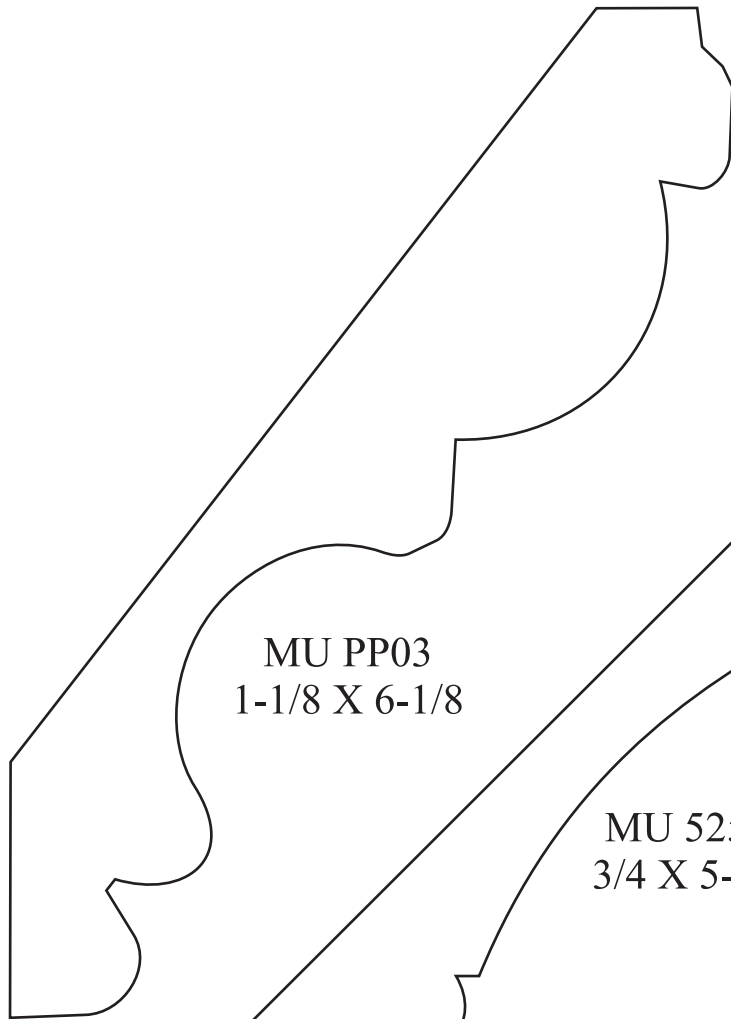

MU PP03  
1-1/8 X 6-1/8

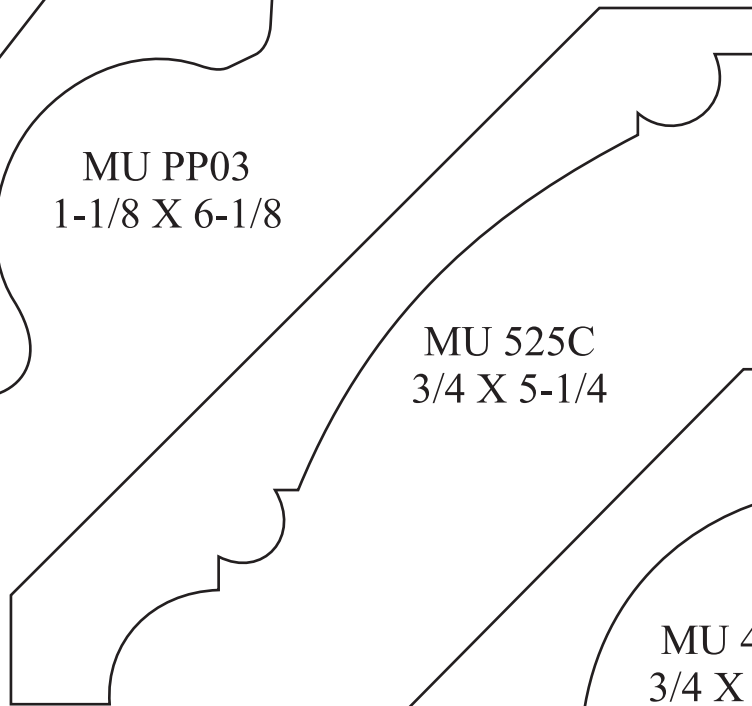

MU 525C  
3/4 X 5-1/4

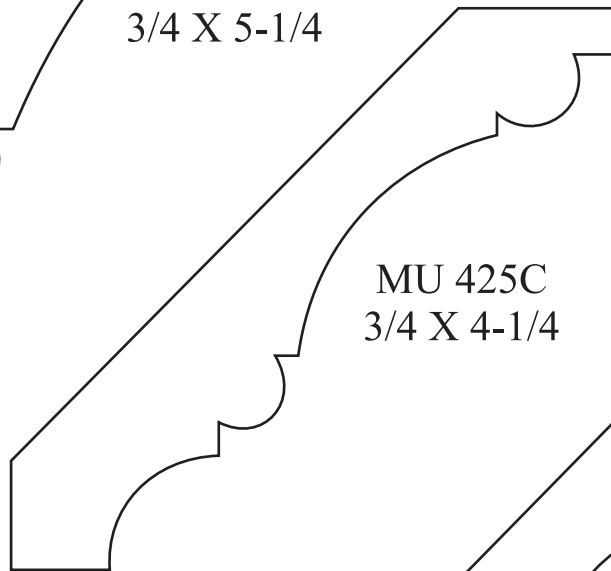

MU 425C  
3/4 X 4-1/4

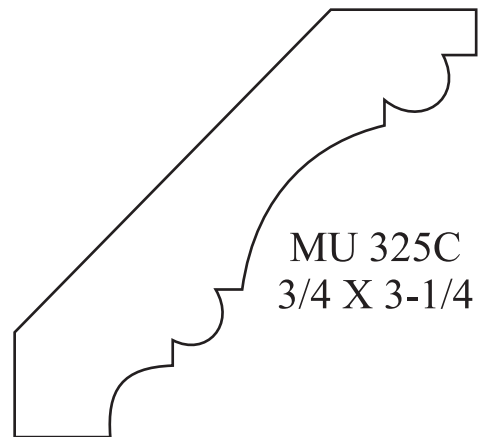

MU 325C  
3/4 X 3-1/4